

AUTOMATIC PRESELECTOR

8445A

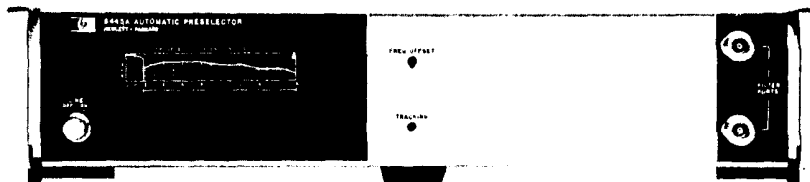

OCTOBER 1971

HEWLETT  PACKARD

HP 8445A

CERTIFICATION

The Hewlett-Packard Company certifies that this instrument was thoroughly tested and inspected and found to meet its published specifications when it was shipped from the factory. The Hewlett-Packard Company further certifies that its calibration measurements are traceable to the U.S. National Bureau of Standards to the extent allowed by the Bureau's calibration facility.

WARRANTY AND ASSISTANCE

All Hewlett-Packard products are warranted against defects in materials and workmanship. This warranty applies for one year from the date of delivery, or, in the case of certain major components listed in the operating manual, for the specified period. We will repair or replace products which prove to be defective during the warranty period provided they are returned to Hewlett-Packard. No other warranty is expressed or implied. We are not liable for consequential damages.

Service contracts or customer assistance agreements are available for Hewlett-Packard products that require maintenance and repair on-site.

For any assistance, contact your nearest Hewlett-Packard Sales and Service Office. Addresses are provided at the back of this manual.

AUTOMATIC PRESELECTOR

8445A

Serial Numbers Prefixed: 1129A

This manual applies directly to HP Model 8445A Automatic Preselectors having the above listed serial prefix numbers.

NOTE

For Preselectors having serial numbers 1119A00110 and below, see Section VII, Manual Changes.

Serial Prefixes Not Listed

For instruments with serial number prefixes not listed, a "Manual Changes" insert is included with this manual.

Copyright HEWLETT-PACKARD COMPANY 1971
1501 PAGE MILL ROAD, PALO ALTO, CALIFORNIA, U.S.A.

Manual Part No. 08445-90002
Microfiche Part No. 08445-90003
Operating Supplement No. 08445-90004

Printed: OCT 1971



TABLE OF CONTENTS

Section	Page	Section	Page
I GENERAL INFORMATION	1-1	IV PERFORMANCE TESTS (cont'd)	4-1
1-1. Introduction	1-1	4-3. Equipment Required	4-1
1-5. Instruments Covered by Manual	1-1	4-5. Front Panel Checks	4-1
1-7. Description	1-1	4-7. Preset Adjustments	4-1
1-9. Options	1-2	4-9. Performance Tests	4-2
1-15. Modifications Required	1-3	4-14. Out-of-Band Rejection	4-2
1-17. Test Equipment Required	1-3	4-15. Low-Pass Filter Insertion Loss	4-4
1-19. Warranty	1-3	4-16. Yig Filter Insertion Loss	4-6
1-21. Accessories Supplied	1-3	4-17. Limiting Level	4-9
1-23. Operating Accessories	1-3		
II INSTALLATION	2-1	V ADJUSTMENTS	5-1
2-1. Initial Inspection	2-1	5-1. Introduction	5-1
2-2. Mechanical Check	2-1	5-4. Equipment Required	5-1
2-4. Electrical Check	2-1	5-6. Factory Selected Components	5-1
2-6. Claims for Damage	2-1	5-8. Power Supplies, Check & Adjustment	5-1
2-9. Preparation for Use	2-1	5-9. Pre-Driver Checks & Adjustments	5-2
2-10. Power Requirements	2-1	5-10. Remote Amplifier Check & Adjustment	5-5
2-13. Power Cable	2-1	5-11. Yig Driver Adjustments (Matched Operation)	5-6
2-16. Operating Environment	2-1	5-12. Yig Driver Adjustments (Linear Operation)	5-9
2-19. Installation Connections	2-2		
2-22. Storage and Shipment	2-2	VI REPLACEABLE PARTS	6-1
2-23. Original Packaging	2-2	6-1. Introduction	6-1
2-27. Other Packaging Materials	2-2	6-4. Ordering Information	6-1
III OPERATION	3-1	VII MANUAL CHANGES	7-1
3-1. Introduction	3-1	7-1. Current Instruments	7-1
3-3. Panel Features	3-1	7-3. Older Instruments	7-1
3-5. Operator's Checks	3-1	7-5. Newer Instruments	7-1
3-7. Operating Instructions	3-1		
3-9. Controls, Indicators and Connectors	3-1	VIII SERVICE	8-1
3-11. Spectrum Analyzer Preselection	3-1	8-1. Introduction	8-1
3-16. Preselector Bandwidth	3-11	8-3. Principles of Operation	8-1
3-18. Recommended Frequency Ranges	3-11	8-5. Recommended Test Equipment	8-1
3-20. Yig Filter 210 Mode	3-12	8-7. Troubleshooting	8-1
3-22. Preselector Tracking with Spectrum Analyzer	3-12	8-11. Repair	8-1
3-25. Preselector Tracking Remote/Manual Operation	3-13	8-20. General Service Hints	8-2
IV PERFORMANCE TESTS	4-1	8-23. General Service Information	8-4
4-1. Introduction	4-1	8-28. Operational Amplifiers	8-5
		8-31. Electrical Maintenance	8-6
		8-33. Mechanical Maintenance	8-6

LIST OF ILLUSTRATIONS

Figure	Page	Figure	Page
1-1. Model 8445A and Accessories	1-0	3-5. Operational Adjustments, 1.8 to 18 GHz	3-8
1-2. Instrument Identification	1-1	3-6. Yig Filter Remote Operation, 1.8–18 GHz	3-10
1-3. Typical Preselector Minimum Insertion Loss @ 25°C	1-2	3-7. Spectrum Analyzer Tuning Curves and Responses	3-11
1-4. RF Interconnect Cable	1-6	3-8. Typical Yig Filter Passband at 1.8 GHz, 10 MHz/DIV Display	3-12
2-1. Power Cable Line Connector Labels	2-2	3-9. Typical Yig Filter Passband at 4 GHz, 10 MHz/DIV Display	3-12
3-1. Front Panel Controls, Connectors and Indicators	3-2	3-10. Typical Yig Filter Passband at 4 GHz, 50 MHz/DIV Display	3-12
3-2. Rear Panel Controls, Connectors and Indicators	3-3	4-1. Out-of-Band Rejection Test Setup	4-3
3-3. Option 020, Controls, Connectors and Indicators	3-4		
3-4. Operational Adjustments, Low-Pass Filter Operation, 10 MHz to 1.8 GHz	3-6		

LIST OF ILLUSTRATIONS (cont'd)

Figure	Page	Figure	Page
4-2. Insertion Loss Test Setup, DC – 1.8 GHz . . .	4-5	8-9. Pre-Driver Assembly A1, Component Location . . .	8-15
4-3. Insertion Loss Test Setup, 1.8–18 GHz . . .	4-7	8-10. Yig Pre-Driver Assembly A1, Schematic Diagram	8-16
4-4. Yig Filter Signal Compression Test Setup . . .	4-9	8-11. Simplified Yig Driver Circuit	8-16
5-1. Power Supply Check and Adjustment Test Setup	5-1	8-12. Simplified Temperature Compensation Circuit	8-16
5-2. Pre-Driver Check and Adjustment Test Setup . . .	5-3	8-13. Drive Circuit with One Breakpoint	8-16
5-3. Remote Amplifier Check and Adjustment Test Setup	5-5	8-14. Yig Driver Assembly A3, Component Location	8-17
5-4. Yig Driver Check and Adjustment Test Setup (Matched Operation)	5-7	8-15. Yig Driver Assembly A3, Schematic Diagram	8-17
5-5. Yig Driver Check and Adjustment Test Setup (Linear Operation)	5-10	8-16. Filter Port Connector, Exploded View	8-18
8-1. Transistor Operation		8-17. Power Supply Assembly A2, Component Location	8-18
8-2. Examples of Diode and Transistor Marking Methods	8-5	8-18. Yig Driver Assembly A3, Component Location	8-19
8-3. Operation Amplifier Equivalent Circuit	8-7	8-19. Remote and Manual Control Amplifier and Switching Circuits, Schematic Diagram	8-19
8-4a. 8445A Preselector, Top Internal View	8-9	8-20. Power Supply Assembly A2, Component Location	8-21
8-4b. 8445A Option 020 Preselector, Top Internal View	8-9	8-21. Power Supply Assembly A2, Schematic Diagram	8-21
8-5. Adjustment and Test Point Locations	8-9		
8-6. Preselector Block Diagram	8-11		
8-7. Preselector Troubleshooting Block Diagram	8-13		
8-8. Hysteresis Reset Circuit Waveforms	8-14		

LIST OF TABLES

Table	Page	Table	Page
1-1. 8445A Specifications	1-2	5-1. Check and Adjustment Test Card	5-13
1-2. Accessories Supplied	1-3	6-1. Abbreviations and Designators used in Parts List	6-1
1-3. Test Equipment and Accessories	1-4	6-2. Replaceable Parts	6-2
1-4. Optional RF Interconnect Cables	1-6	6-3. Code List of Manufacturers	6-7
3-1. Recommended Frequency Ranges and Mixing Modes	3-12	8-1. Factory Selected Components	8-1
4-1. Performance Test Card	4-11	8-2. Adjustable Components	8-2
		8-3. Schematic Diagram Notes	8-3
		8-4. Etched Circuit Soldering Equipment	8-4

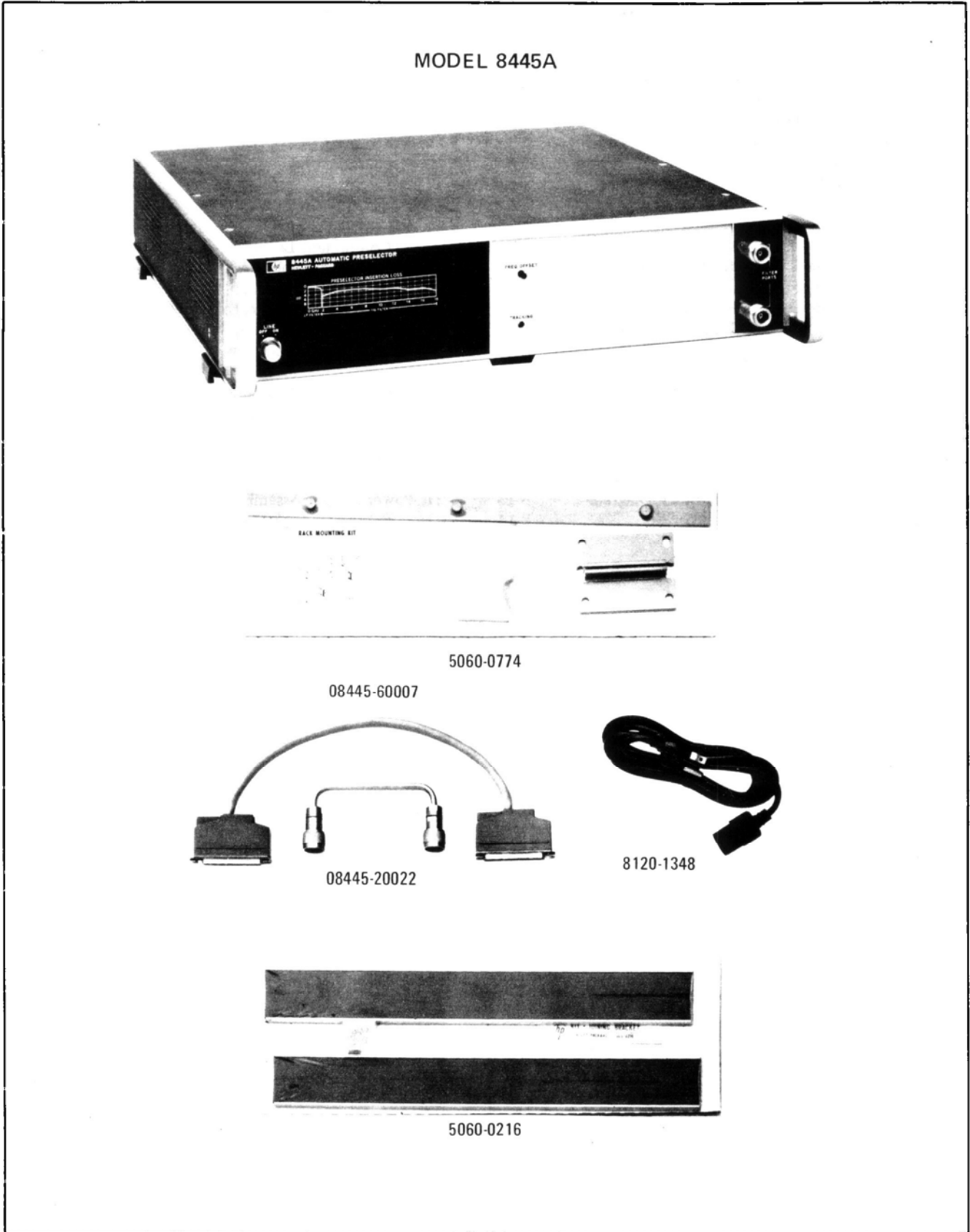

Figure 1-1. Model 8445A and Accessories

SECTION I GENERAL INFORMATION

1-1. INTRODUCTION

1-2. This manual contains all information required to install, operate, test, adjust and service the Hewlett-Packard Model 8445A Automatic Preselector. This section covers instrument identification, description, options, accessories, specifications and other basic information.

1-3. Figure 1-1 shows the Hewlett-Packard Model 8445A Automatic Preselector with accessories supplied.

1-4. The various sections in this manual provide information as follows:

SECTION II, INSTALLATION, provides information relative to incoming inspection, power requirements, mounting, packing and shipping, etc.

SECTION III, OPERATION, provides information relative to operating the instrument.

SECTION IV, PERFORMANCE TESTS, provides information required to ascertain that the instrument is performing in accordance with published specifications.

SECTION V, ADJUSTMENTS, provides information required to properly adjust and align the instrument after repairs are made.

SECTION VI, REPLACEABLE PARTS, provides ordering information for all replaceable parts and assemblies.

SECTION VII, MANUAL CHANGES, normally will contain no relevant information in the original issue of a manual. This section is reserved to provide back-dated and up-dated information in manual revisions or reprints.

SECTION VIII, SERVICE, includes all information required to service the instrument.

1-5. INSTRUMENTS COVERED BY MANUAL

1-6. Hewlett-Packard instruments carry a serial number (see Figure 1-2) on the back panel. When the serial number prefix on the instrument serial number plate of your instrument is the same as one of the prefix numbers on the inside title page of this manual, the manual applies directly to the

instrument. When the instrument serial number prefix is not listed on the inside title page of initial issue, manual change sheets and manual up-dating information is provided. Later editions or revisions to the manual will contain the required change information in Section VII.

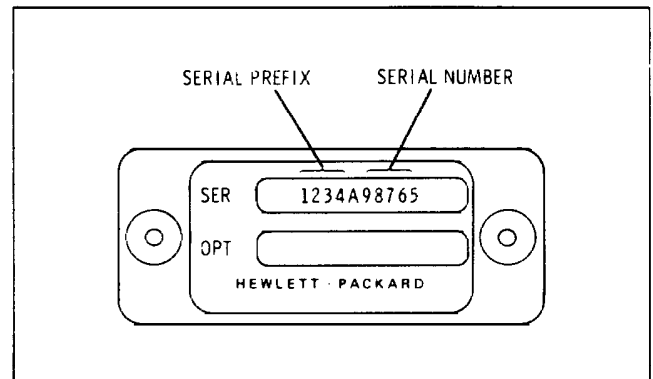

Figure 1-2. Instrument Identification

1-7. DESCRIPTION

1-8. The Model 8445A Automatic Preselector is designed to complement the Model 8555A Spectrum Analyzer RF Section. The Preselector covers the frequency range of 0 to 18 GHz. When used with the 8555A Spectrum Analyzer, the Preselector functions to reduce or eliminate signal inter-modulation, and multiple and spurious responses. The Preselector is a fixed frequency lowpass filter over the 0 to 1.8 GHz frequency range and a voltage tuned filter, using a Yig (yttrium-iron-garnet) crystal as a resonant tuning circuit in the RF signal path, over the frequency range of 1.8 to 18 GHz. When used with the 8555A Spectrum Analyzer, the Yig filter is a swept selective filter that tracks the frequency of the analyzer's response as the analyzer sweeps across its selected range. The Yig filter is electronically tuned by sweep voltage and band code signals from the analyzer. In addition to its primary function as a Preselector, the Yig filter may be used as a manually or electronically tuned bandpass filter. The Yig filter may be tuned by external sweep voltage or manually tuned by front panel controls.

Table 1-1. 8445A Specifications

Frequency Range: DC– 1.8 GHz Low-Pass Filter. 1.8 –18 GHz Tracking Filter.

Tracking Filter 3 dB Bandwidth: Typically 30–45 MHz.

Tracking Filter Skirt Roll-off: Characteristics of a two-pole filter.

Insertion Loss:

	Frequency	Insertion Loss Std. & Opt. 020	Insertion Loss Opt. 010 & 030
Low-pass Filter	DC–1.8 GHz @ 2.05 GHz	<2.5 dB >50 dB	*
Tracking Filter	1.8–12 GHz 12 –18 GHz	< 7 dB <10 dB	< 6 dB < 8 dB

*Low-Pass Filter deleted with Options 010 and 030.

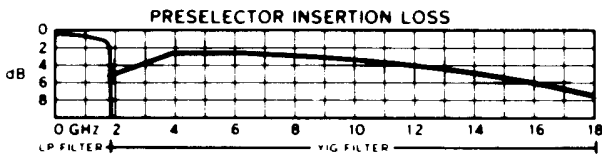

Figure 1-3. Typical Preselector Minimum Insertion Loss @ 25°C

Input VSWR: Typically <1.8 (1.8–18 GHz).

Out-of-Band Rejection: For YIG filter 1 GHz from center of passband >50 dB, typically 55 dB.

Tracking Errors: At any particular frequency residual tracking error can be completely eliminated by front panel adjustments.

8555A Local Oscillator Emission with Preselector: Typically <–50 dBm over recommended operating ranges with Spectrum Analyzer input attenuator set to 0 dB. (See Table 3-1, Recommended Frequency Ranges and Mixing Modes).

Limiting Level: (Maximum input level for < 1 dB signal compression. > +5 dBm.

Burnout Level: > +17 dBm.

Remote Function: YIG filter frequency can be set by externally supplied voltage. Differential input utilized to eliminate AC hum or other common mode signals which may be present on remote drive input cable.

Sensitivity: Nominally +1 volt/GHz (with direction of tuning from low to high frequency).

Differential Input Resistance: 2K ohms.

Common Mode Rejection Ratio: 80 dB.

YIG 210 Response: Typically 20 dB down from main mode tuning response.

Settling Time: Typically within 3 MHz of final frequency after 5 msec.

Tuning Linearity: Typically ±10 MHz.

Remote Input Connector: BNC female, outer conductor isolated.

1-9. OPTIONS

1-10. The Model 8445A Automatic Preselector (standard instrument) contains the 0 to 1.8 GHz lowpass filter, the Yig filter with type N RF input and output connectors.

1-11. The Model 8445A Option 001 Automatic Preselector contains type APC-7 RF input and output connectors. Option 001 instruments may be combined with other instrument options to form the desired configuration.

1-12. The Model 8445A Option 010 Automatic Preselector is the same as the standard Preselector except the 1.8 GHz lowpass filter is deleted.

1-13. The Model 8445A Option 020 Automatic Preselector is the same as the standard Preselector with front panel controls added for manual operation.

1-14. The Model 8445A Option 030 Automatic Preselector is the same as Option 020 without the 1.8 GHz lowpass filter.

1-15. MODIFICATIONS REQUIRED

1-16. HP Model 140T Display Sections (serials prefixed 1105A and below), HP Model 141T Display Sections (serials prefixed 1047A and below), all HP Model 141S/140S Display Sections and all HP Model 140-series Oscilloscope Mainframes require modification for Preselector compatibility. The modification consists of adding a cable assembly to the Display Section. This cable connects between the Auxiliary "B" output connector on the rear panel of the 8555A RF Section and the rear panel of the Display Section. Modification kit, HP Part Number 00140-69505, required for 140T Display Sections (serials prefixed 1105A and below), 141T Display Sections (serials prefixed 1047A and below) and all 140S/141S Option TG-1 Display Sections. Modification Kit, HP Part Number 00140-69504, is required for 140S/141S Display Section other than Option TG-1. The modification kits, containing all necessary parts and information, are available from any Hewlett-Packard Sales and Service Office. (A list of Sales and Service Offices is contained in the back of this manual.) Service Notes P-00140-69504A and P-00140-69505 contain the modification procedure. The appropriate Service Note is included with the modification kit. Cable wiring information is contained in the 8555A RF Section Operating and Service Manual. (See Service Sheet 16, wiring to Auxiliary "B" connector.)

1-17. TEST EQUIPMENT REQUIRED

1-18. Table 1-3 lists the test equipment and accessories required to check, adjust and repair the

Preselector. If substitute equipment is used it must meet the Minimum Specifications listed in Table 1-3.

1-19. WARRANTY

1-20. The 8445A Automatic Preselector is warranted and certified as indicated on the inner front cover of this manual. For further information contact the nearest Hewlett-Packard Sales/Service Office; addresses are provided at the back of this manual.

1-21. ACCESSORIES SUPPLIED

1-22. Table 1-2 lists the accessories supplied with the Preselector. The accessories supplied are for a standard installation which provides for the Preselector to be mounted on and joined with an 8555A Spectrum Analyzer. This configuration allows the instruments to be either bench or rack mounted. A different mounting installation will require a different RF cable to connect between the Preselector output and the Spectrum Analyzer input. The power cable supplied with the instrument is selected at time of shipment. Selection is based on shipping destination. Figure 2-1 illustrates the different power cable connectors that are currently available.

1-23. OPERATING ACCESSORIES

1-24. Operating accessories for use with the Preselector are listed in Table 1-4. Operating accessories include various lengths of rigid coaxial cable for interconnecting the Preselector with the Spectrum Analyzer. See Table 1-4 for cable length and connector type. Cable dimensions are illustrated in Figure 1-4.

Table 1-2. Accessories Supplied

HP Part Number	Name	Description
8120-1348*	Line Power Cable	7½ feet, 3-wire Ac Line Cord
08445-20022**	RF Interconnect Cable	Rigid Coaxial Cable, Connects Preselector RF output to Spectrum Analyzer RF Input. Type N connectors.
08445-60007	Interconnect Cable	18 inch Control Cable, interconnects Preselector with Spectrum Analyzer.
5060-0774	Rack Mounting Kit	Hardware and parts for mounting Preselector in 19-inch rack.
5060-0216	Joining Bracket Kit	Hardware and parts for strapping Preselector to Spectrum Analyzer.

* See paragraph 2-15 and Figure 2-1.

**See paragraph 1-24 and Figure 1-4. ITEM NOT SUPPLIED WITH OPT OSD

Table 1-3. Test Equipment and Accessories (1 of 2)

Item	Minimum Specifications	Suggested Model	Use*
Frequency Comb Generator	Frequency markers spaced 1, 10, 100 MHz apart; usable to 8 GHz Frequency Accuracy: $\pm 0.01\%$ Output Amplitude: > -40 dBm to 2 GHz	HP 8406A Comb Generator	A, T
Signal Generator	Frequency Range: 1.8 – 4.0 GHz Frequency Accuracy: $\pm 1\%$ Output Amplitude: $> +5$ dBm Output Impedance: 50 ohms	HP 8616A/B Signal Generator	P, A
Sweep Oscillator	Frequency Range: 2.0 – 18 GHz Output Amplitude: > -5 dBm Output Impedance: 50 ohms	HP 8690B Sweep Oscillator with 8692B RF Unit 8693B RF Unit 8694B RF Unit 8695A RF Unit	P, A
Digital Voltmeter	Voltage Accuracy: $\pm 0.01\%$ of reading +0.01% of range Resolution: ± 1 mV @ 10 volts Overrange: 50% Input Impedance: 10 megohms Polarity: Automatic Indication	HP 3480B Digital Multimeter with HP 3484A Multi-Function Unit	A, T
Oscilloscope	Frequency Range: dc to 50 MHz Time Base: 1 μ s/div to 10 ms/div Time Base Accuracy: $\pm 3\%$ Dual Channel, Alternate Operation AC or dc Coupling External Sweep Mode Voltage Accuracy: $\pm 3\%$ Sensitivity: 0.005 V/div	HP 180A with HP 1801A Vertical Amplifier and HP 1821A Horizontal Amplifier HP 10004 10:1 Divider Probes (2)	T
Power Meter	Frequency Range: 0.01–18.0 GHz Accuracy: $\pm 1\%$ Power Range: -20 to $+10$ dBm	HP 432A Power Meter with HP 8478B Thermistor Mount	P
Power Supply Dual DC	Output Voltage: Variable, 0 – 20 Vdc Output Current: 0–300 mA Meter Accuracy: 3% Control: Fine adjustment	HP 6205B Power Supply	P, A, T
DC Volt-Ohm-Ammeter	Voltmeter Voltage Range: 1 mV – 300 V Accuracy: $\pm 1\%$ Input Resistance: 10 megohms Ammeter Current Range: 1 μ A – 1A Accuracy: $\pm 2\%$ Ohmmeter Resistance range: 1 ohm – 100 megohm Accuracy: $\pm 5\%$ reading at center scale	HP 412A Volt Ohm-Ammeter	T
*A = Adjustments; T = Troubleshooting; P = Performance			

Table 1-3. Test Equipment and Accessories (2 of 2)

Item	Minimum Specifications	Suggested Model	Use*
Spectrum Analyzer	Frequency Range: 0.01 – 18 GHz Frequency Response: $< \pm 2.0$ dB	HP 8555A Spectrum Analyzer with HP 8552 IF Section and HP 141T Display Section	P, A, T
AC Voltmeter	Voltage Accuracy: $\pm 3\%$ of full scale Voltage Range: 300 V full scale Input Impedance: 10 megohms	HP 410C Multifunction Voltmeter	A
Variable Voltage Transformer	Voltage Range: 102 – 127 Vac	General Radio W5MT3A or Superior Electric UC1M	A
Coaxial Cable	Male BNC Connectors, 44 inches long with alligator clips	HP 10501A Cable Assy w/alligator clips	P, A
Frequency Meter	Frequency Range: 2 – 18 GHz Overall Accuracy: 0.2%	HP 536A/537A/P532A Frequency Meters	A
Swept Frequency Indicator	Sensitivity: 5 dB/div Blanking: 0 – 5 V gate Vertical Input Impedance: 75K ohms	HP 1416A Swept Frequency Indicator	A
Directional Coupler (2 each)	Frequency Range: Usable from 2 – 18 GHz	HP 779D Directional Coupler	A
10 dB Coaxial Attenuator	Frequency Range: DC – 18 GHz	HP 8491B Coaxial Attenuator, Option 010	A
Crystal Detector	Frequency Range: 1.8 – 18 GHz	HP 8470A Crystal Detector	A
Crystal Detector	Frequency Range: Usable to 18 GHz	HP 423A Crystal Detector	A
Adapter	APC-7 to Type N male	HP 11525A	A
* A = Adjustments; T = Troubleshooting; P = Performance			

Table 1-4. Optional RF Interconnect Cables

Part No.	Connector Type	Mounting Configuration	Dim. "A" (inches)	Dim. "B" (inches)
11670A	Type N	Preselector below Spectrum Analyzer	5.006	6.130
11670B	APC-7	Preselector below Spectrum Analyzer	5.006	6.130
11670C	Type N	Preselector above Spectrum Analyzer	3.596	4.720
11670D	APC-7	Preselector above Spectrum Analyzer	3.596	4.720
11670E	Type N	Preselector below Spectrum Analyzer — Rack mounted	4.866	5.990
11670F	APC-7	Preselector below Spectrum Analyzer — Rack mounted	4.866	5.990
11670G	Type N	Preselector above Spectrum Analyzer — Rack mounted	3.456	4.580
11670H	APC-7	Preselector above Spectrum Analyzer — Rack mounted	3.456	4.580
11670J	Type N	Preselector below Spectrum Analyzer — Joining Bracket Kit	4.646	5.770
11670K	APC-7	Preselector below Spectrum Analyzer — Joining Bracket Kit	4.646	5.770
11670M	APC-7	Preselector above Spectrum Analyzer — Joining Bracket Kit	3.236	4.360

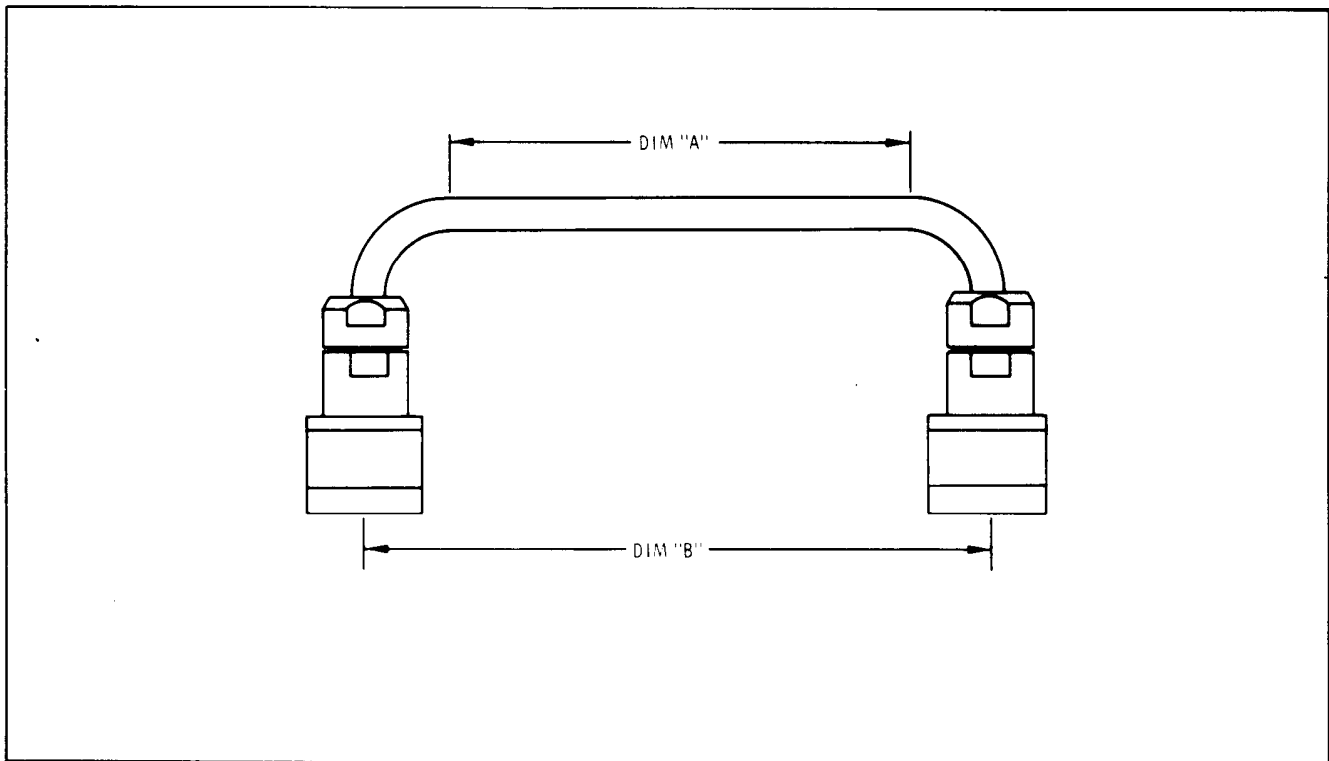

Figure 1-4. RF Interconnect Cable

SECTION II INSTALLATION

2-1. INITIAL INSPECTION

2-2. Mechanical Check

2-3. Check the shipping carton for evidence of damage immediately after receipt. If there is any visible damage to the carton, request the carrier's agent be present when the instrument is unpacked. Inspect the instrument for physical damage such as bent or broken parts and dents or scratches. If damage is found refer to paragraph 2-6 for recommended claim procedures. If the instrument appears to be undamaged, perform the electrical check (see paragraph 2-4). The packaging material should be retained for possible future use.

2-4. Electrical Check

2-5. The electrical check consists of following the performance test procedures listed in Section IV. These procedures allow the operator to determine that the instrument is, or is not, operating within the specifications listed in Table 1-1. The initial performance and accuracy of the instrument are certified as stated on the inside front cover of this manual. If the instrument does not operate as specified, refer to paragraph 2-6 for the recommended claim procedure.

2-6. CLAIMS FOR DAMAGE

2-7. If physical damage is found when the instrument is unpacked, notify the carrier and the nearest Hewlett-Packard Sales/Service office immediately. The Sales/Service office will arrange for repair or replacement without waiting for a claim to be settled with the carrier.

2-8. The warranty statement for the instrument is on the inside front cover of this manual. Contact the nearest Sales/Service office for information about warranty claims.

2-9. PREPARATION FOR USE

CAUTION

Before applying power, check the power selector switch on the Preselector input power line module (rear panel) for proper position (115 or 230 volts).

2-10. Power Requirements

2-11. The Preselector can be operated from a 50- to 60-Hertz input line that supplies either 115- or

230-volt ($\pm 10\%$ in each case) power. Consumed power is normally less than 65 watts.

2-12. The 115/230 power selector switch on the rear panel power line module of the Preselector must be set to agree with the available line voltage. The selector switch is located below the fuse holder and fuse extractor lever. An arrow on the selector switch points to callouts listing the line input voltage and fuse amperage rating. To change the position of the selector switch it is necessary to remove the power cable, slide the protective cover to the left and lift the fuse extractor before the switch can be changed. With the fuse extractor extended, press down and toward the desired direction. Replace fuse with a fuse of the amperage rating for the selected position. See Section VI for replacement HP Part Numbers. The instrument is normally shipped with fuse installed for 115-volt operation.

2-13. Power Cable

2-14. To protect operating personnel, the National Electrical Manufacturers' Association (NEMA) and the International Electrotechnical Commission (IEC) recommends that the instrument panel and cabinet be grounded. The Preselector is equipped with a three-conductor power cable; the third conductor is the ground conductor and when the cable is plugged into an appropriate receptacle, the instrument is grounded. To preserve the protection feature when operating the instrument from a two-contact outlet, use a three-prong to two-prong adapter and connect the green or green/yellow lead on the adapter to ground.

2-15. Power cables are selected for shipment with each instrument; with a line connector plug to match the standard power cord for the country of destination on the purchase order. A label indicating the power cable inside is affixed to the packing case. Figure 2-1 indicates the connector plugs and the HP part numbers for the various available power cables.

2-16. OPERATING ENVIRONMENT

2-17. A forced-air cooling system is used to maintain required operating temperatures within the instrument. The air intake and filter are located on the rear of the instrument; warm air is exhausted through the side panel perforations. When operating the instrument, choose a location which pro-

SECTION III OPERATION

3-1. INTRODUCTION

3-2. This section provides complete operation instructions for the HP 8445A Automatic Preselector. Front and rear panel controls, connectors and indicators for the basic model Preselector are identified and described in Figures 3-1 and 3-2. Front panel controls, connectors and indicators for the HP 8445A, Option 020, Automatic Preselector are identified and described in Figure 3-3. Operational adjustments are detailed in Figure 3-4 and 3-5. Additional operating information is contained in Figures 3-6 through 3-10.

3-3. PANEL FEATURES

3-4. Front and rear panel features of the 8445 Automatic Preselector are described in Figures 3-1 and 3-2. Front and rear panel views of the Preselector connected to the HP 8555A/8552A/141T Spectrum Analyzer are shown in Figures 3-4 and 3-5. For a detailed description of the Spectrum Analyzer controls and indicators refer to the appropriate operating and service manuals for those instruments. Interconnection wiring between the Preselector and the Spectrum Analyzer is contained in Section VIII of this manual.

3-5. OPERATOR'S CHECKS

3-6. Upon receipt of the instrument, or when the Preselector is to be used with a different analyzer, perform the operational adjustment procedures listed in Figure 3-5. This procedure corrects for minor differences between the Preselector and the Spectrum Analyzer. Additionally, some improvement can be made in Preselector tracking with a particular analyzer by matching the Yig filter tuning with the analyzer tuning. (See Preselector Tracking, paragraph 3-22 and Yig Driver Adjustment, paragraph 5-11).

3-7. OPERATING INSTRUCTIONS

3-8. General operating instructions are contained in Figures 3-4 and 3-5. These instructions will familiarize the operator with basic operating functions of the Preselector in use with the Spectrum Analyzer. Additional operating techniques and information are contained in Figures 3-6 through 3-10.

3-9. CONTROLS, INDICATORS AND CONNECTORS

3-10. Front and rear panel controls, indicators, and connectors are identified and briefly described in Figures 3-1 through 3-3. Operational adjustment procedures are given in Figures 3-4 through 3-6. Additional information, to assist the user during instrument operation, is given in the following paragraphs.

3-11. SPECTRUM ANALYZER PRESELECTION

3-12. The 8555A Spectrum Analyzer RF Section has a 2.05 to 4.1 GHz local oscillator and a 2050 or 550 MHz first IF. The analyzer responds to signals within the 10 MHz to 18 GHz range when using internal mixing. In some cases the open front end, and harmonic mixing of the analyzer, present problems of signal interpretation. The Preselector is used to eliminate unwanted responses on the CRT display. The Preselector uses a low-pass filter over the frequency range of dc to 1.8 GHz and a Yig filter as a microwave resonator in the RF signal path over the frequency range of 1.8 to 18 GHz. The Yig filter is electronically tuned to track a selected analyzer RF tuning response, virtually eliminating multiple image and spurious responses.

CAUTION

Installation of a coaxial attenuator or a coaxial isolator at the Preselector input FILTER PORT is recommended when operating with signal sources that are not capable of absorbing their own reflected power. Signals outside the passband of the Preselector are reflected back to the source.

3-13. Multiple responses occur when the local oscillator harmonics cause more than one display for a single input frequency. For example, when a 9.5 GHz signal is fed to the analyzer RF INPUT, responses due to the 2+, 3-, 4-, and 5- mixing modes appear on the display (see Figure 3-7). Follow the signal frequency line for 9.5 GHz across the figure noting the intersections with solid lines representing mixing modes. The Preselector tracks the selected mixing mode so that responses from other mixing modes are not present on the display.

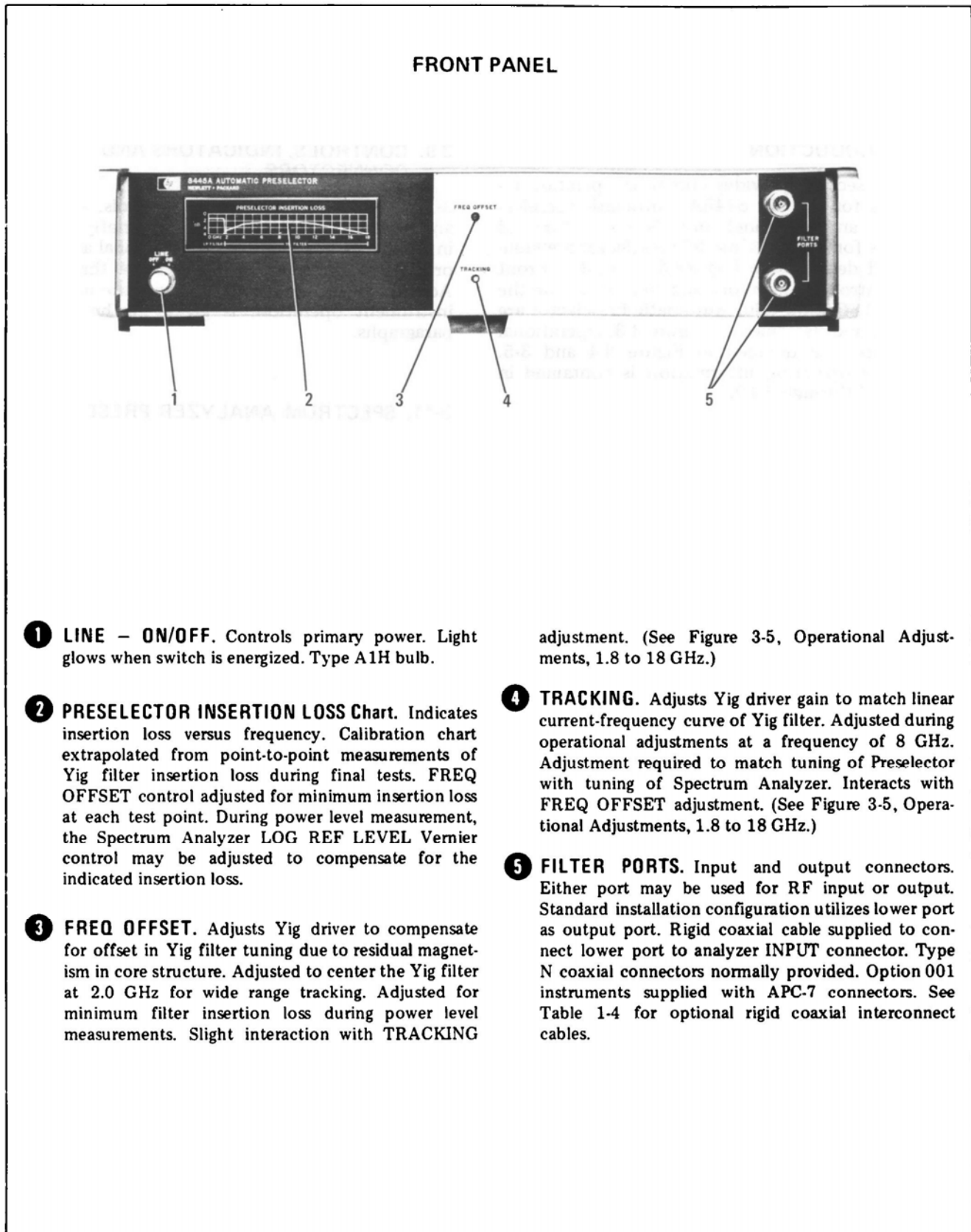

Figure 3-1. Front Panel Controls, Connectors and Indicators

OPTION 020

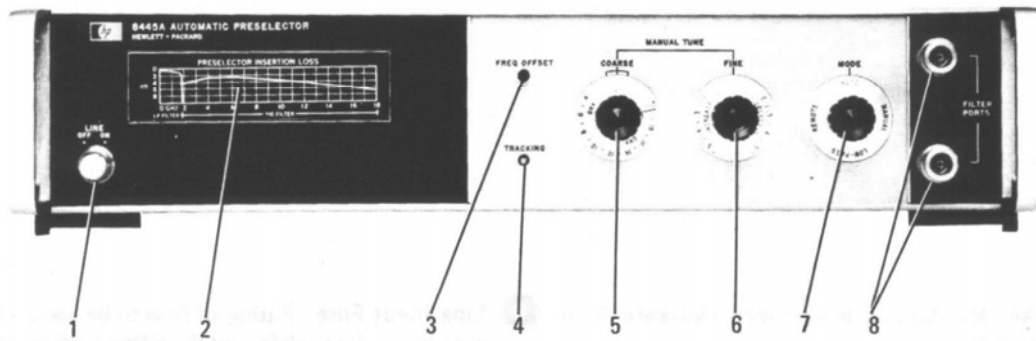

Figure 3-3. Option 020, Controls, Connectors and Indicators (1 of 2)

OPTION 020

- 1 **LINE – ON/OFF.** Controls primary power. Light glows when switch is energized. Type A1H bulb.
- 2 **PRESELECTOR INSERTION LOSS Chart.** Indicates insertion loss versus frequency. Calibration chart extrapolated from point-to-point measurements of Yig filter insertion loss during final tests. **FREQ OFFSET** control adjusted for minimum insertion loss at each test point. During power level measurement, Spectrum Analyzer **LOG REF LEVEL** Vernier control may be adjusted to compensate for the indicated insertion loss.
- 3 **FREQ OFFSET.** Adjusts Yig driver to compensate for offset in Yig filter tuning due to residual magnetism in core structure. Adjusted to center the Yig filter at 2.0 GHz for wide range tracking. Adjusted for minimum filter insertion loss during power level measurements. (See Figure 3-5, Operational Adjustments, 1.8 to 18 GHz.)
- 4 **TRACKING.** Adjusts Yig driver gain to match linear current-frequency curve of Yig filter. Adjusted during operational adjustments at a frequency of 8 GHz. Adjustment required to match tuning of Preselector with tuning of Spectrum Analyzer. Interacts with **FREQ OFFSET** adjustment. (See Figure 3-5, Operational Adjustments, 1.8 to 18 GHz.)
- 5 **COARSE – Option 020/030 instruments.** Manual Yig filter frequency tune control. Sets Yig filter center frequency in manual operating mode.
- 6 **FINE – Option 020/030 instruments.** Fine tune control for Yig filter frequency in manual operating mode.
- 7 **MODE – Option 020/030 instruments.** Selects Pre-selector mode of operation. **MANUAL** – Yig filter tuned by front panel controls. **AUTO** – Low-pass filter and/or Yig filter selected by control signals from analyzer RF Section. Yig frequency tuned by signal from RF Section. **REMOTE** – Yig filter tuned by input voltage to BNC connector on rear panel. **LOW-PASS** – Selects 1.8 GHz low-pass filter. Inhibits Spectrum Analyzer control of Preselector.
- 8 **FILTER PORTS.** Input and output connectors. Either port may be used for RF input or output. Standard installation configuration utilizes lower port as output port. Rigid coaxial cable supplied to connect lower port to analyzer **INPUT** connector. Type N coaxial connectors normally provided. Option 001 instruments supplied with APC-7 connectors. See Table 1-4 for optional rigid coaxial interconnect cables.

Figure 3-3. Option 020, Controls, Connectors and Indicators (2 of 2)

OPERATIONAL ADJUSTMENTS

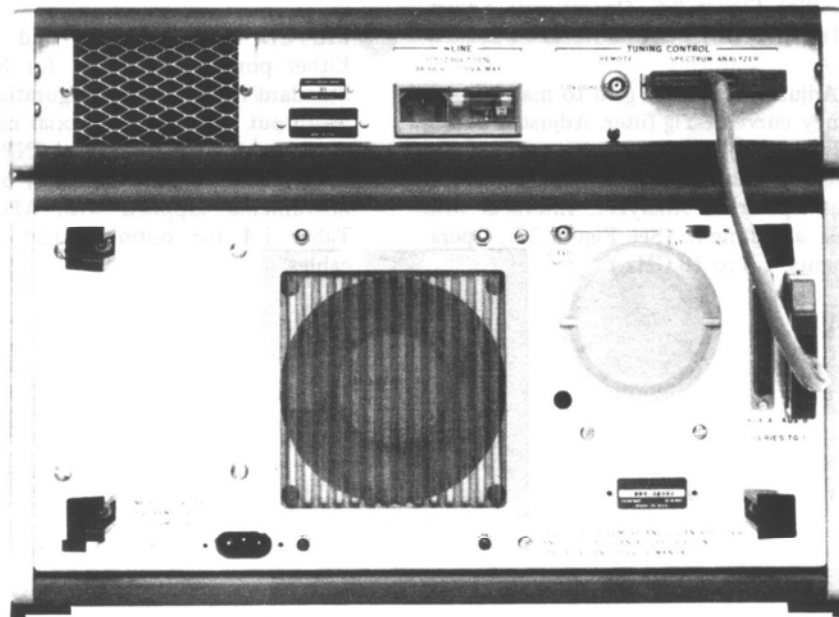
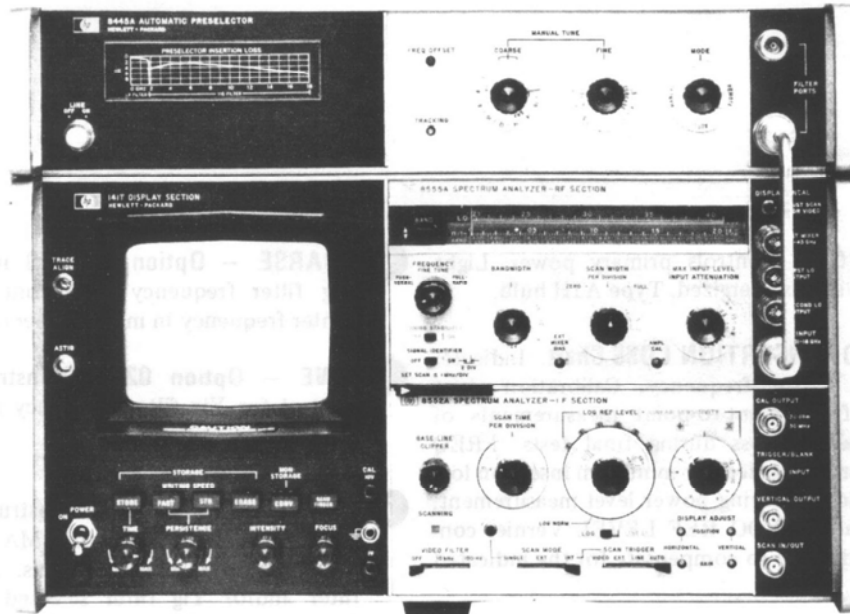

Figure 3-4. Operational Adjustments, Low-Pass Filter Operation, 10 MHz to 1.8 GHz (1 of 2)

OPERATIONAL ADJUSTMENTS

1. Check that the 115/230V switch is set to correspond with the available line voltage. Refer to Figure 3-2, steps 4, 5, and 6 for switch and fuse information.
 2. Connect interconnect cable between AUX B output on Spectrum Analyzer Display Section and TUNING CONTROL – SPECTRUM ANALYZER input on Preselector.
 3. Connect Preselector and Spectrum Analyzer to line voltage source and apply power.
 4. Perform Spectrum Analyzer Operational Adjustments, Figure 3-3, in Spectrum Analyzer RF Section 8555A Operating and Service Manual.
- Note
- Automatic Preselector Options 010/030 do not have low-pass filter installed (see Figure 3-5).
5. Set analyzer LOG/LINEAR switch to LINEAR and rotate LOG REF LEVEL control until 1 mV/DIV is matched with the lighted index lamp.
 6. Connect Analyzer CAL OUTPUT to upper filter port of Preselector.
 7. Connect rigid coaxial cable between FILTER PORT and Analyzer INPUT.
 8. Note and record low-pass filter insertion loss at 30 MHz. From the LIN 7 to 5 line equals approximately 3 dB. Low-pass filter insertion loss should be <1 dB.
 9. Remove rigid coaxial cable connecting Preselector FILTER PORT to Analyzer INPUT.
 10. Set Analyzer INPUT ATTENUATION to 40 dB.
 11. Set Analyzer LOG/LINEAR control to LOG.
 12. Rotate LOG REF LEVEL control to (+) 10 dBm.
 13. Set SCAN WIDTH PER DIVISION to 10 MHz and set FREQUENCY control to position cursor at 1.5 GHz on Frequency Scale.
 14. With INPUT ATTENUATION at 40 dB, connect Analyzer SECOND LO OUTPUT to INPUT.
 15. Center 1.5 GHz LO signal on CRT display. Reduce SCAN WIDTH PER DIVISION to 0.2 MHz, keeping signal centered on CRT with FREQUENCY control.
 16. Rotate LOG REF LEVEL control fully counterclockwise.
 17. Set LOG/LINEAR switch to LINEAR and adjust LINEAR SENSITIVITY controls for a 7.1 division display of the 1.5 GHz signal.
 18. Disconnect cable at Analyzer INPUT and connect to upper FILTER PORT on Preselector.
 19. Connect rigid coaxial cable between lower Preselector FILTER PORT and Analyzer INPUT.
 20. Note and record low-pass filter insertion loss at 1.5 GHz. From the LIN 7 to 5 line equals approximately 3 dB. 1.5 GHz low-pass filter insertion loss ≤ 2.5 dB.
 21. Set LOG/LINEAR switch to LOG. Set LOG REF LEVEL Vernier control to compensate for the amount of insertion loss indicated in step 20.
 22. The Preselector and Analyzer are now calibrated at 1.5 GHz.
 23. Remove cable between upper filter port and SECOND LO OUTPUT.
 24. Install 50 ohm termination on SECOND LO OUTPUT connector.
 25. Connect signal (10 MHz to 1.8 GHz) under investigation to upper FILTER PORT of Preselector.
 26. Set LOG REF LEVEL vernier control to compensate for insertion loss using data obtained in steps 8 or 20 above or the data on the PRESELECTOR INSERTION LOSS chart.

Figure 3-4. Operational Adjustments, Low-Pass Filter Operation, 10 MHz to 1.8 GHz (2 of 2)

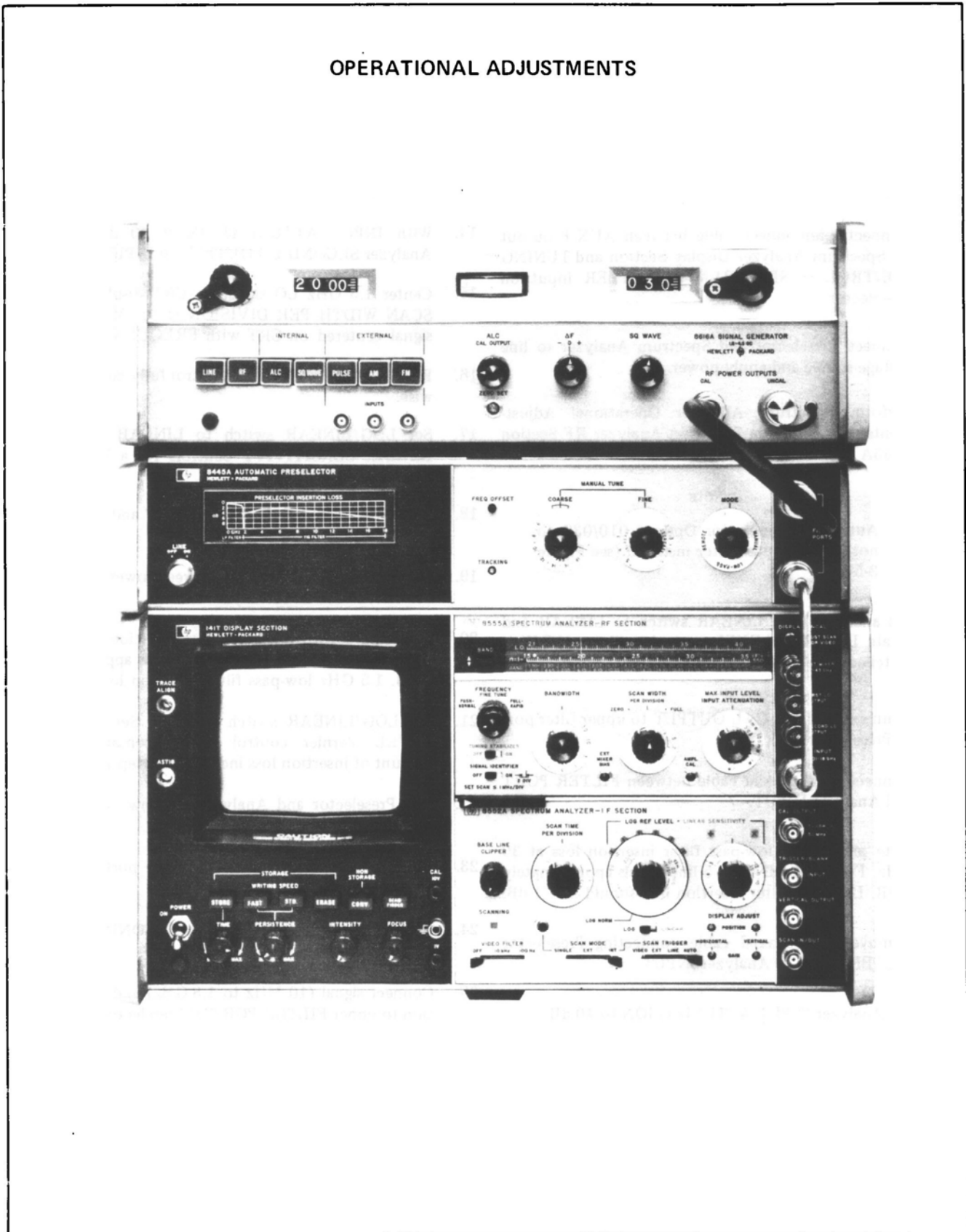

Figure 3-5 (Operational Adjustments, 1.8 to 18 GHz (1 of 2))

OPERATIONAL ADJUSTMENTS

1. Check that the 115/230V switch is set to correspond with the available line voltage. Refer to Figure 3-2, steps 4, 5, and 6 for switch and fuse information.
2. Connect interconnect cable between AUX B output on Spectrum Analyzer Display Section and TUNING CONTROL — SPECTRUM ANALYZER input on Preselector.
3. Connect Preselector and Spectrum Analyzer to line voltage source and apply power.
4. Perform Spectrum Analyzer Operational Adjustments, Figure 3-3, in Spectrum Analyzer RF Section 8555A Operating and Service Manual.
5. Connect rigid coaxial cable between lower FILTER PORT on Preselector and RF Section INPUT.
6. Set LOG REF LEVEL to 0 dBm.
7. Set SCAN WIDTH PER DIVISION to 10 MHz.
8. Connect a -30 dBm 2.0 GHz signal to upper FILTER PORT on Preselector.
9. Select $n=1$ * Frequency BAND and tune Analyzer FREQUENCY control to center the 2.0 GHz signal on CRT display.
10. Reduce SCAN WIDTH PER DIVISION to 0.5 MHz keeping signal centered on display with FREQUENCY control.
11. Reduce SCAN WIDTH PER DIVISION to 100 kHz; center signal on display with FINE TUNE control.
12. Set LOG/LINEAR switch to LINEAR and LINEAR SENSITIVITY control to 1 mV/DIV.
13. Adjust Preselector FREQ OFFSET control to center Yig filter passband on the 2 GHz signal. Center indicated by slight dip between two signal peaks. (See Figure 3-8).
14. Set Analyzer LOG/LINEAR control to LOG.
15. Rotate LOG REF LEVEL control to -30 dBm.
16. Adjust LOG REF LEVEL Vernier control to position signal peak on LOG REF LEVEL graticule line.
17. Connect a -30 dBm 8.0 GHz signal to upper FILTER PORT on Preselector.
18. Select $n=2$ + Frequency BAND on Analyzer, set SCAN WIDTH PER DIVISION to 10 MHz, and tune FREQUENCY control to center the 8.0 GHz signal on CRT display.
19. Reduce SCAN WIDTH PER DIVISION to 0.5 MHz keeping signal centered on display with FREQUENCY control.
20. Reduce SCAN WIDTH PER DIVISION to 100 kHz; center signal on display with FINE TUNE control.
21. Set LOG/LINEAR switch to LINEAR and LINEAR SENSITIVITY control to 1 mV/DIV.
22. Adjust Preselector TRACKING control to maximize signal on CRT display.
23. If signal is already at maximum, no further adjustment of FREQ OFFSET or TRACKING is required.
24. If signal was not at maximum, repeat steps 7 through 22 until a setting is found which satisfies requirements of steps 13 and 22.

Figure 3-5. Operational Adjustments, 1.8 to 18 GHz (2 of 2)

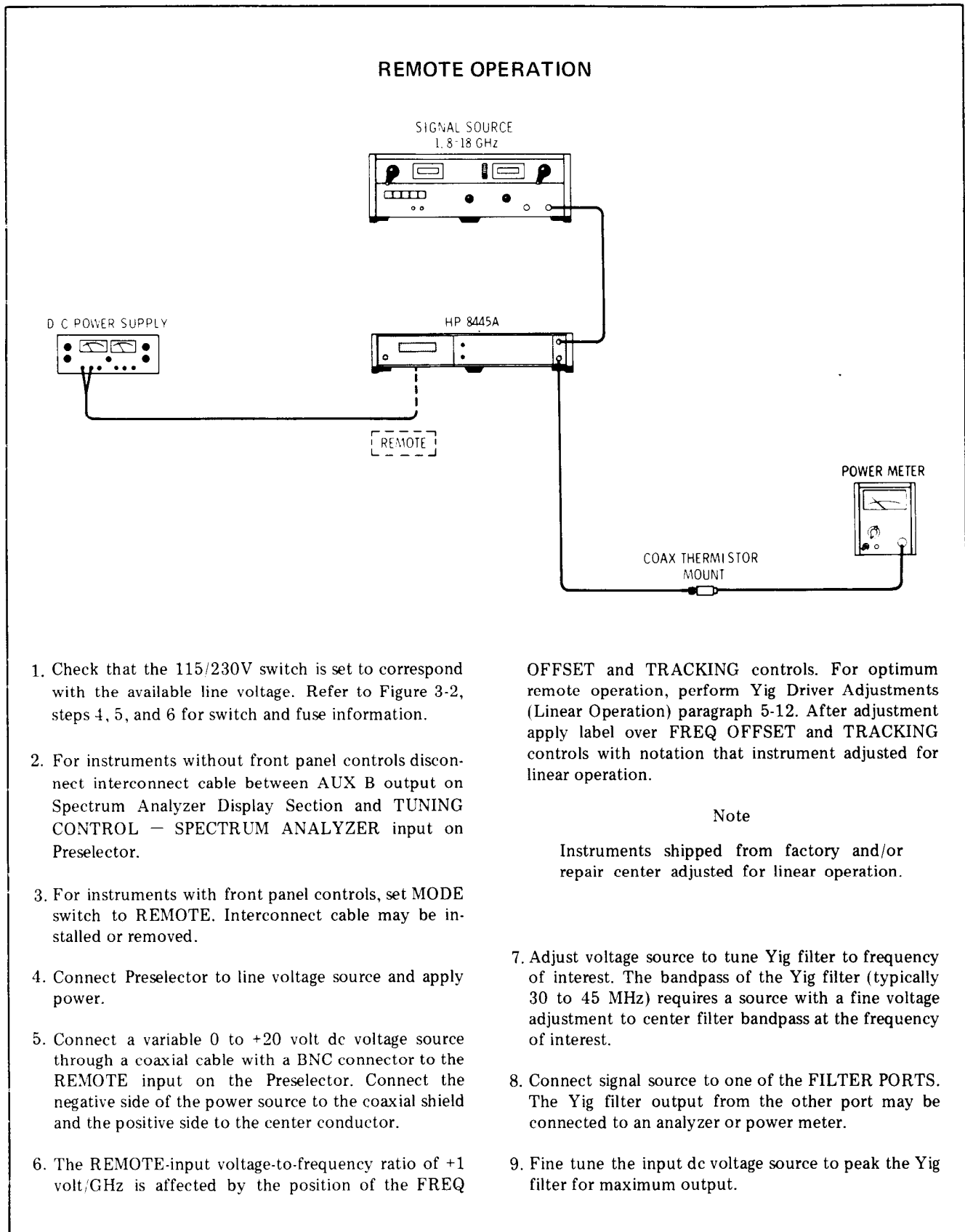

Figure 3-6. Yig Filter Remote Operation, 1.8 to 18 GHz

3-14. When the analyzer local oscillator is tuned to 3 GHz (2050 MHz 1st IF), image responses may occur at different frequencies. (Refer to Figure 3-7.) Follow the 3 GHz local oscillator line up the figure noting the intersections with solid lines representing mixing modes. Each of these signals appear at the same place on the display, and are products of the different mixing modes. The Preselector eliminates images by allowing only selected frequency bands to enter the analyzer's RF INPUT, and allowing only one mixing mode to be used at one time.

3-15. Spurious signal responses are caused when strong signals enter the RF INPUT of the analyzer, and are of sufficient amplitude to cause intermodulation products. The narrow bandwidth of the Preselector tuning response (35 MHz nominal) acts to eliminate spurious signal responses on the display. Signals that are farther apart than the Preselector bandwidth cannot appear in the analyzer input at the same time.

3-16. PRESELECTOR BANDWIDTH

3-17. The Yig filter has a 3 dB bandwidth that is typically 30 to 45 MHz. At the low frequency end of the filter range, overcoupling causes a passband with double peak (see Figure 3-8). The slight dip between the two peaks indicates the center of the filter bandpass and the point of adjustment for the FREQ OFFSET control. At frequencies above 4 GHz the passband has a single peak (see Figure 3-9). At frequencies, the FREQ OFFSET may be adjusted for maximum output level. For wideband frequency tracking, the FREQ OFFSET control should be adjusted at a frequency of approximately 2 GHz. For narrow band tracking with minimum filter insertion loss, the FREQ OFFSET control should be adjusted at the frequency of interest.

Note

Measurement conditions for Figures 3-8 through 3-10. Analyzer bandwidth 300 kHz, 10 dB log. Preselector fixed-tuned to frequency indicated. Input signal tuned through passband.

3-18. RECOMMENDED FREQUENCY RANGES

3-19. Table 3-1 lists the recommended frequency ranges for operation of the Preselector with the Spectrum Analyzer. Analyzer responses, tracked by the Preselector, overlap at the edges of different frequency bands. Note the intersection of the n=1+ and n=3- responses at 4.1 GHz in Figure 3-7. Signals near the intersection points can appear in the passband of the Preselector from both mixing modes.

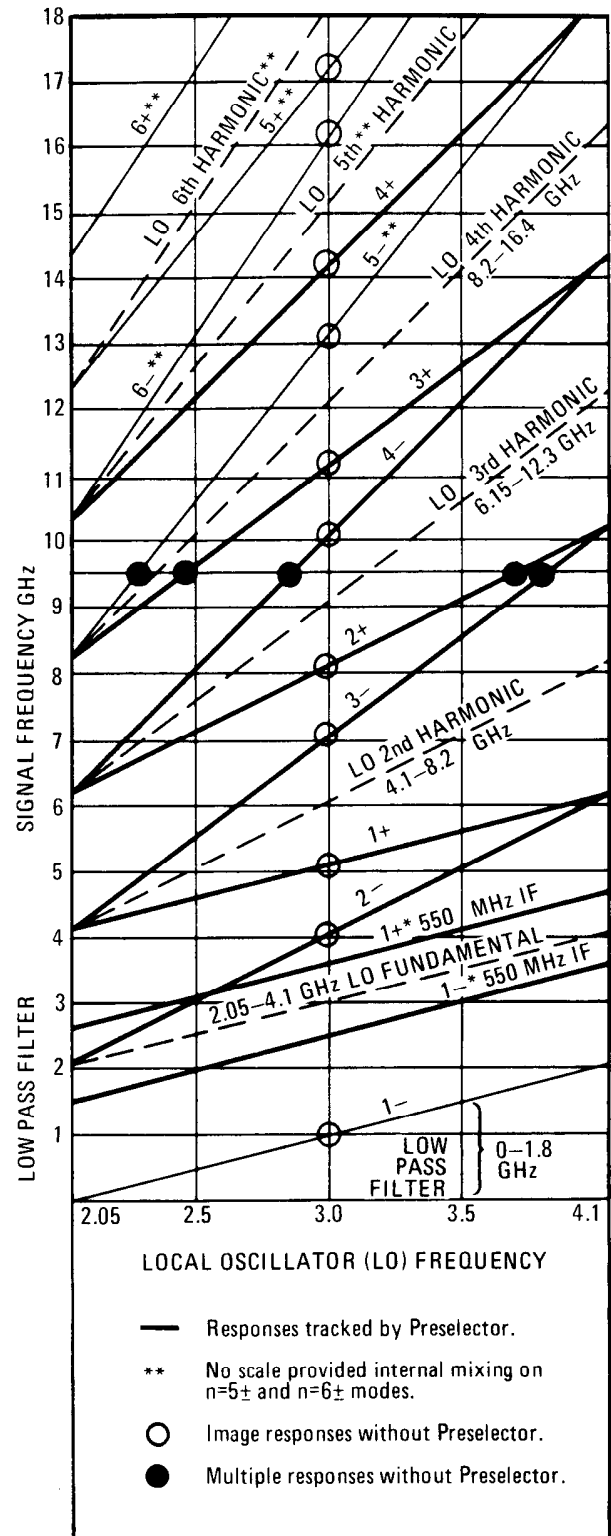

Figure 3-7. Spectrum Analyzer Tuning Curves and Responses

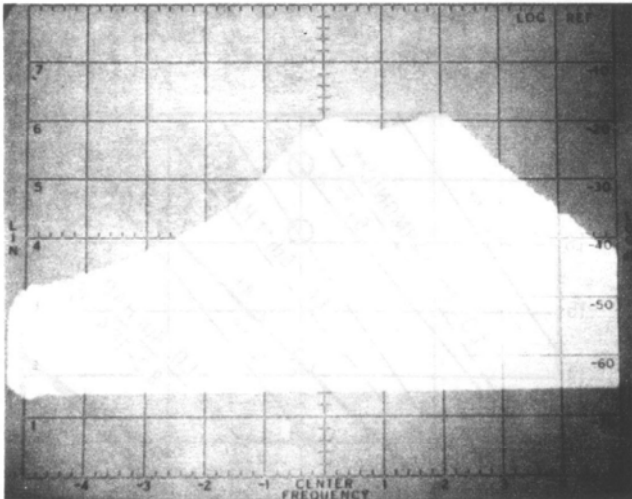
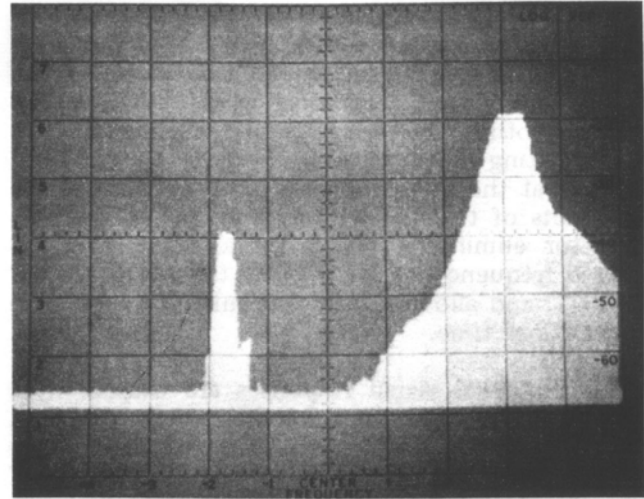

Figure 3-8. Typical Yig Filter Passband at 1.8 GHz, 10 MHz/DIV Display



210 MODE MAIN MODE

Figure 3-10. Typical Yig Filter Passband at 4 GHz, 50 MHz/DIV Display

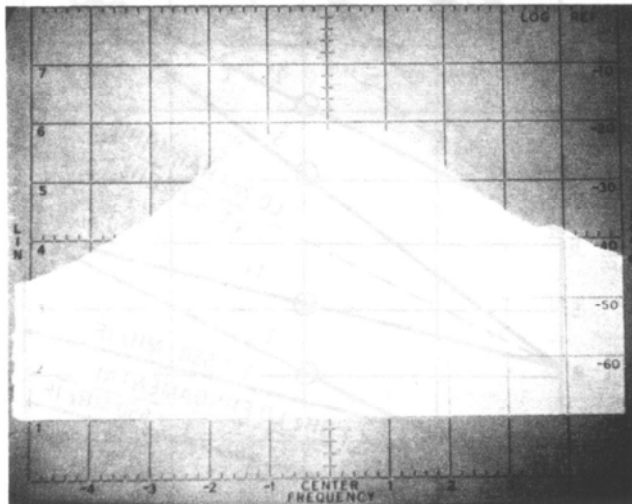

Figure 3-9. Typical Yig Filter Passband at 4 GHz, 10 MHz/DIV Display

3-20. YIG FILTER 210 MODE

3-21. The 210 mode is illustrated in Figure 3-10. The passband of the 210 mode is approximately 10 MHz wide with an amplitude approximately 20 dB below the main tuning mode. The 210 mode tracks with the main tuning mode at a frequency approximately 240 MHz below the main mode.

3-22. PRESELECTOR TRACKING WITH SPECTRUM ANALYZER

3-23. The Preselector Yig driver is adjusted during the final factory checkout, for linear tracking with a linear input voltage. The upper frequency breakpoints are set by applying an exact voltage and tuning the bandpass to a fixed frequency. This procedure provides optimum tracking for Preselector operation with any 8555A Spectrum Analyzer System. Some improvement can be made in Preselector (on n=3 and n=4 bands) by matching the

Table 3-1. Recommended Frequency Ranges and Mixing Modes

Signal Frequency GHz	Analyzer Scan Time ≤ 10 ms/DIV		
	Recommended Harmonic	Analyzer Freq. Range GHz	Analyzer IF Freq. MHz
0.01 – 1.8	1–	0.01 – 2.05	2050
1.8 – 3.5	1–*	1.50 – 3.55	550
2.8 – 4.5	1+*	2.60 – 4.65	550
2.8 – 5.5	2–	2.07 – 6.15	2050
4.3 – 5.8	1+	4.11 – 6.15	2050
4.9 – 9.0	3–	4.13 – 10.25	2050
6.6 – 9.5	2+	6.17 – 10.25	2050
7.3 – 13.0	4–	6.19 – 14.35	2050
9.0 – 13.3	3+	8.23 – 14.35	2050
11.0 – 18	4+	10.29 – 18.00	2050

Preselector to a particular Spectrum Analyzer RF Section. In the matching procedure, the Preselector driver is adjusted by tuning the passband to track the analyzer tuning response at selected frequencies. Both of the above procedures are contained in Section V (Yig Driver Adjustments, paragraphs 5-11 and 5-12) of this manual. Additional improvement can be made, in matched operation, by a more accurate adjustment of the Yig driver in the 8555A Spectrum Analyzer RF Section. In the normal adjustment procedure, the RF Section Yig driver is adjusted with a tolerance of $\pm .005$ Vdc, which is equivalent to ± 5 MHz in LO tuning. On the n=4 bands, the voltage to the Yig driver in the RF Section and the voltage to the Preselector could be off as much as $\pm .020$ Vdc or 20 MHz. By adjusting the Yig driver in the 8555A to a tolerance of $\pm .002$ Vdc, the error in the output voltage to the Preselector can cause only a ± 8 MHz tuning error on the n=4 band. This error is well within the passband of the Preselector.

3-24. Preselector tracking on the n=1 through n=2 bands is controlled by front panel **FREQ OFFSET**

and **TRACKING** controls. Correct adjustment will provide hands-off tracking through 10.5 GHz. At frequencies below approximately 4.0 GHz, there is some error in signal amplitude when tracking in the center of the passband (see Figure 3-8). The Preselector insertion loss calibration curve is based on a signal tuned to the peak in the passband, not to the center passband dip. For accurate amplitude measurements, adjust **FREQ OFFSET** for maximum signal level at frequency of measurement.

3-25. PRESELECTOR TRACKING REMOTE/ MANUAL OPERATION

3-26. Preselector tracking in both **REMOTE** and **MANUAL** operating modes is affected by the front panel **FREQ OFFSET** and **TRACKING** controls. Adjustment of these controls changes the accuracy of the +1 volt/GHz remote tuning and the dial accuracy of the manual controls. To adjust **FREQ OFFSET** and **TRACKING** controls for **REMOTE** or **MANUAL** operation perform adjustment procedures in paragraph 5-12, Yig Driver Adjustments (Linear Operation).

SECTION IV PERFORMANCE TESTS

4-1. INTRODUCTION

4-2. This section contains front panel checks and performance tests for the 8445A Automatic Pre-selector. Front panel checks for routine inspection are given in paragraph 4-5. Procedures for verifying that the instrument meets specifications are given in paragraphs 4-14 through 4-17. The front panel checks, preset adjustments and performance test should be performed using the 8555A Spectrum Analyzer System that will normally be used with the Preselector.

4-3. EQUIPMENT REQUIRED

4-4. Test equipment and test accessories for performance (P), adjustment (A), and troubleshooting (T) are listed in Table 1-3. Critical specifications and/or required features for the test equipment and accessories are contained in the test equipment and test accessories table.

4-5. FRONT PANEL CHECKS

4-6. Before proceeding to the performance tests, the instrument must be adjusted and all controls set as specified in the preset adjustment instructions in paragraphs 4-7 and 4-8. After the instrument controls are preset, proceed with the front panel checks and adjustments. The instrument should perform as called out in the preset adjustment procedures before going on to the performance tests (paragraphs 4-14 through 4-17).

4-7. Preset Adjustments

4-8. Install Preselector with Spectrum Analyzer. Ensure that the 115/230V line selector switch is set to correspond with the available line voltage. Connect interconnect cable between AUX B output on the Display Section and TUNING CONTROL — SPECTRUM ANALYZER input on the Preselector. Connect Preselector and Spectrum Analyzer to line voltage source and apply power. While the instruments are warming up, make the following control settings:

- a. PRESELECTOR (with manual controls):
 MODE AUTO
- b. SPECTRUM ANALYZER:
 BAND n=1— (2.05 GHz IF)
 FREQUENCY 30 MHz

- FINE TUNE Centered
- BANDWIDTH 100 kHz
- SCAN WIDTH PER DIVISION
- SCAN WIDTH PER DIVISION 10 MHz
- INPUT ATTENUATION 10 dB
- SIGNAL IDENTIFIER OFF
- BASE LINE CLIPPER CCW
- SCAN TIME PER DIVISION
 10 MILLISECONDS
- LOG/LINEAR LOG
- LOG REF LEVEL 0 dBm
- LOG REF LEVEL Vernier 0
- VIDEO FILTER OFF
- SCAN MODE INT
- SCAN TRIGGER LINE

c. Connect Spectrum Analyzer CAL OUTPUT to INPUT.

d. Adjust FREQUENCY to align LO feed-through signal on the -3 graticule line.

e. Check level of 30 MHz signal at CENTER FREQUENCY line. Signal level should be -30 dBm. Perform AMPL CAL Adjustment if signal level is incorrect. (See 8555A Operating and Service Manual.)

Note

Preselectors with Options 010 and 030 do not have low-pass filters installed. Disregard steps f, g, h, and i.

f. Connect Spectrum Analyzer CAL OUTPUT to upper FILTER PORT on Preselector.

g. Connect lower FILTER PORT on Preselector to Spectrum Analyzer INPUT.

h. Check level of 30 MHz signal at CENTER FREQUENCY graticule line. There should be little or no change in level of the -30 dBm signal through the low-pass filter in the Preselector.

i. Select BAND n=1+ 550 MHz IF. Note that there is an audible click (from coaxial switches in the Preselector) and the signal disappears from the CRT display.

j. Select BAND n=1- 550 MHz IF. Connect lower FILTER PORT to Spectrum Analyzer INPUT.

k. Connect a 2.0 GHz -30 dBm signal to upper FILTER PORT.

- l. Tune Spectrum Analyzer to center 2.0 GHz signal on CRT display.
- m. Adjust Preselector FREQ OFFSET to center passband at 2.0 GHz.
- n. Select BAND n=2+ and connect a 8.0 GHz, -30 dBm signal to Preselector upper FILTER PORT.
- o. Tune Spectrum Analyzer FREQUENCY control to center signal on CRT display.
- p. Adjust Preselector TRACKING control to maximize signal level on CRT display.
- q. Repeat steps j through p for optimum adjustment.

4-9. PERFORMANCE TESTS

4-10. The performance tests, given in this section, are suitable for incoming inspection, troubleshooting, or preventive maintenance. During any performance test, all shields and connecting hardware must be in place. The tests are designed to verify published instrument specifications. Perform

the tests in the order given, and record data on test card (Table 4-1) and/or in the data spaces provided in each test.

4-11. The tests are arranged in the following order:

Paragraph	Test Description
4-14	Out-of-Band Rejection
4-15	Low-Pass Filter Insertion Loss
4-16	Yig Filter Insertion Loss
4-17	Limiting Level (Signal Compression)

4-12. Each test is arranged so that the specification is written as it appears in Table 1-1, Specifications. Next, a description of the test and any special instructions or problem areas are included. Each test that requires test equipment has a test setup drawing and a list of required equipment. Step 1 of each procedure gives control settings required for that particular test.

4-13. Required minimum specifications for test equipment are detailed in Table 1-3. If substitute test equipment is used, it must meet the specifications listed in order to performance-test the Preselector.

PERFORMANCE TESTS

4-14. Out-of-Band Rejection

SPECIFICATION: For Yig filter 1 GHz from center of passband >50 dB, typically 55 dB.

DESCRIPTION: The Yig filter is tuned to a fixed frequency (either manually or remotely). A signal is applied through the filter and the power output level measured. The signal source is then shifted 1 GHz and the power output level is again measured. The difference between the two power levels is the out-of-band rejection for 1 GHz frequency separation.

PERFORMANCE TESTS

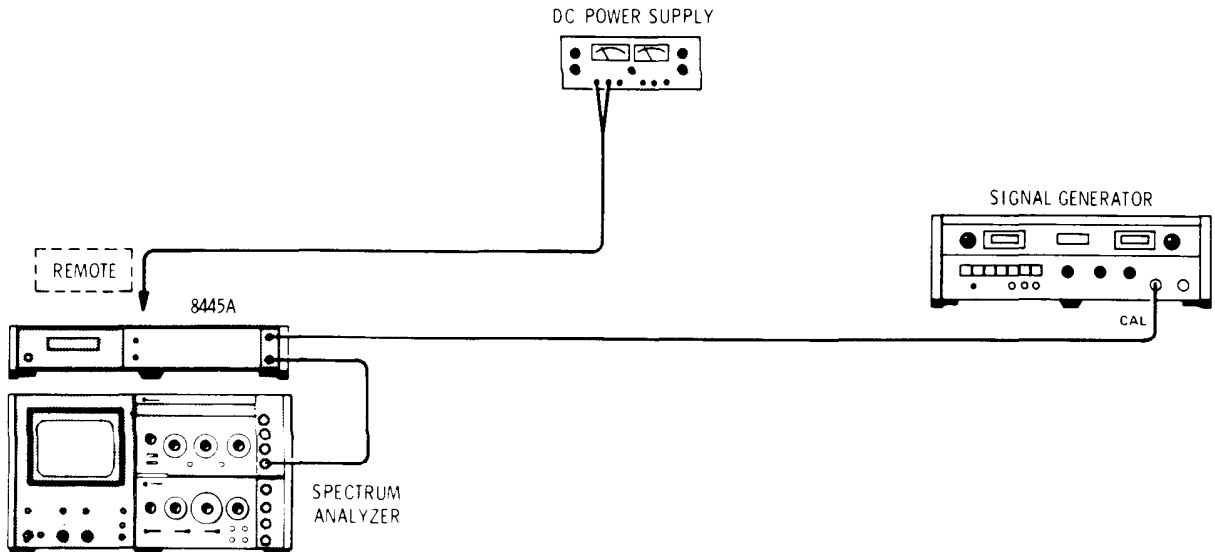

Figure 4-1. Out-of-Band Rejection Test Setup

EQUIPMENT:

Spectrum Analyzer	HP 8555A/8552/141T
Signal Generator	HP 8616B
Power Supply*	HP 6205B
Coaxial Cable (BNC to alligator clips)*	HP 10501A

*Required for Preselectors without manual controls.

1. Connect test setup as indicated in Figure 4-1 and make the following control settings:

PRESELECTOR: (without manual controls)

LINE OFF/ON ON
 Interconnect Cable Disconnected

PRESELECTOR: (with manual controls)

LINE OFF/ON ON
 MODE MANUAL
 MANUAL TUNE COARSE 3 GHz
 MANUAL TUNE FINE 0 GHz

POWER SUPPLY:

Output Voltage +3 Vdc

ANALYZER:

BAND n=2—
 FREQUENCY 3 GHz
 BANDWIDTH 300 kHz
 SCAN WIDTH PER DIVISION 10 MHz

PERFORMANCE TESTS

4-14. Out-of-Band Rejection (cont'd)

INPUT ATTENUATION 10 dB
 BASE LINE CLIPPER 12 o'clock
 SCAN TIME PER DIVISION 10 MILLISECONDS
 LOG REF LEVEL -20 dBm
 LOG/LINEAR LOG
 VIDEO FILTER 10 kHz

SIGNAL GENERATOR:

FREQUENCY 3 GHz
 ATTENUATION -20 dB
 ALC CAL OUTPUT 0 dBm (on meter)

2. Adjust Signal Generator frequency to center signal in Preselector passband indicated by maximum signal level displayed on CRT.
3. Adjust Spectrum Analyzer FREQUENCY control to center signal on CRT display.
4. Record Signal Generator frequency. _____
5. Adjust Spectrum Analyzer LOG REF LEVEL Vernier control to set signal peak on CRT LOG REF line.
6. Set Spectrum Analyzer INPUT ATTENUATION to 0 dB.
7. Tune Generator to a frequency 1 GHz above that recorded in step 4 above. Record frequency.
8. Tune Spectrum Analyzer to frequency of Signal Generator. _____
9. Center Signal Generator signal on CRT display.
10. Reduce Spectrum Analyzer BANDWIDTH to 30 kHz and SCAN WIDTH PER DIVISION to 0.5 MHz. Center signal on CRT display with FINE TUNE control.
11. Set Analyzer INPUT ATTENUATION to 10 dB.
12. Note and record signal level. Signal should be at least 50 dB below the reference level set in step 5 above.

Out-of-Band Rejection _____

4-15. Low-Pass Filter Insertion Loss

SPECIFICATION: Low-Pass Filter Insertion Loss; DC - 1.8 GHz: <2.5 dB, @ 2.05 GHz >50 dB.

DESCRIPTION: Insertion loss is measured at the high end of the filter's operating range by applying a known input power level and measuring the output power level. Filter rejection at 2.05 GHz is measured in the same manner.

PERFORMANCE TESTS

4-15. Low-Pass Filter Insertion Loss (cont'd)

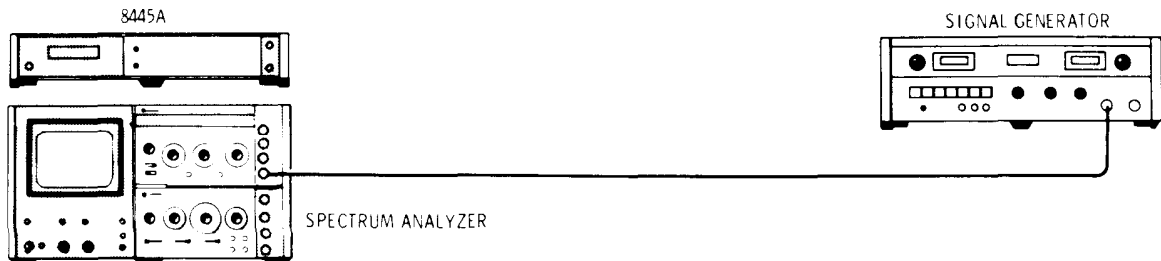

Figure 4-2. Insertion Loss Test Setup, DC — 1.8 GHz

EQUIPMENT:

Spectrum Analyzer HP 8555A/8552/141T
 Signal Generator HP 8616B

1. Connect test setup as indicated in Figure 4-2 and make the following control settings:

PRESELECTOR:

LINE OFF/ON ON

ANALYZER:

BAND n=1 — (2.05 GHz IF)
 FREQUENCY 1.8 GHz
 BANDWIDTH 300 kHz
 SCAN WIDTH PER DIVISION 10 MHz
 INPUT ATTENUATION 10 dB
 BASE LINE CLIPPER 9 o'clock
 SCAN TIME PER DIVISION 10 MILLISECONDS
 LOG REF LEVEL -20 dBm
 LOG/LINEAR LOG
 VIDEO FILTER 10 kHz
 SCAN MODE INT
 SCAN TRIGGER AUTO
 POWER ON

SIGNAL GENERATOR:

LINE On
 RF On
 ALC On
 FREQUENCY 1800 MHz
 ATTENUATION 10 dB

PERFORMANCE TESTS

4-15. Low-Pass Filter Insertion Loss (cont'd)

2. Center 1.8 GHz signal on CRT display with FREQUENCY control. Set TUNING STABILIZER to ON and reduce SCAN WIDTH PER DIVISION to 100 kHz. Center signal on CRT display with FINE TUNE control.
 3. Adjust Signal Generator CAL OUTPUT level for an indicated -20 dBm on CRT display.
 4. Connect Signal Generator output to upper FILTER PORT on Preselector.
 5. Connect lower FILTER PORT to Analyzer INPUT.
 6. Note and record signal level. _____ dB
 7. Insertion loss should not exceed 2.5 dB.
 8. Record insertion loss. ≤ 2.5 dB _____ dB
 9. Set Analyzer SCAN WIDTH PER DIVISION to 5 MHz.
 10. Tune Analyzer and Signal Generator to 2050 MHz.
 11. Note and record insertion loss. ≥ 50 dB _____ dB
-

4-16. Yig Filter Insertion Loss

SPECIFICATION: Tracking Filter Insertion Loss: 1.8 – 12 GHz, 7 dB (Standard and Option 020); 6 dB (Option 010 and 030); 12 – 18 GHz, 10 dB (Standard and Option 020); 8 dB (Option 010 and 030).

DESCRIPTION: Yig filter insertion loss is measured at fixed frequency points by applying a known signal level, tuning the Yig filter passband to the signal and measuring the power out the filter output port. Perform the operational adjustment procedure in Figure 3-5 prior to performing the test below. The operational adjustment procedure sets the FREQ OFFSET and TRACKING controls in addition to checking the insertion loss at 2.0 and 8.0 GHz. The Yig filter is tuned by applying a voltage to the REMOTE input. Voltage to frequency tuning ratio is 1 GHz/volt. The Preselector FREQ OFFSET control is used as a fine tuning control.

PERFORMANCE TESTS

4-16. Yig Filter Insertion Loss (cont'd)

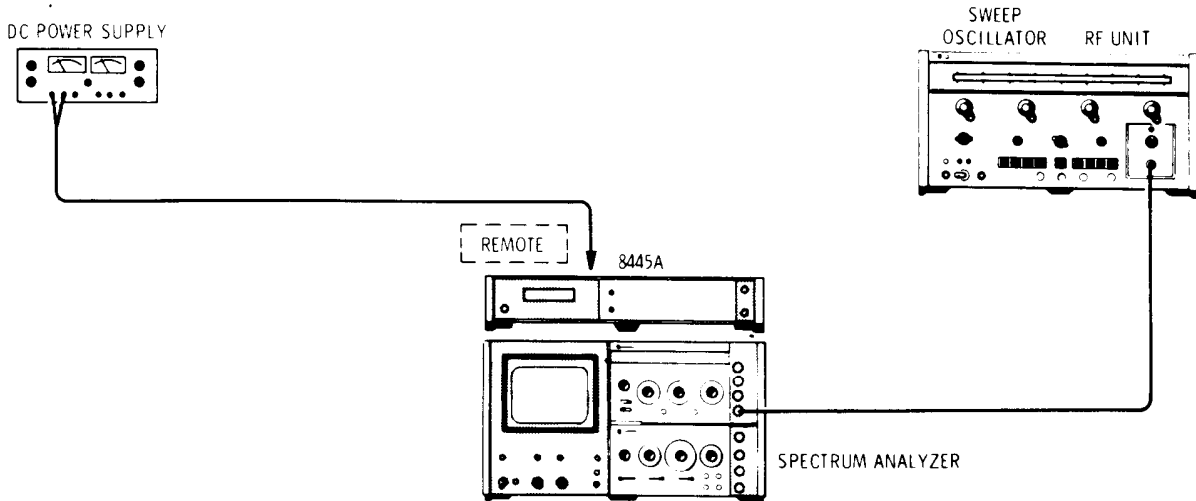

Figure 4-3. Insertion Loss Test Setup, 1.8 –18 GHz

EQUIPMENT:

Spectrum Analyzer	HP 8555A/8552/141T
Sweep Oscillators	HP 8690B/8692B/8693B/8694B/8695A
Power Supply	HP 6205B
Coaxial Cable (BNC to alligator clips)	HP 10501A

1. Connect test setup as indicated in Figure 4-3 and make the following control settings.

PRESELECTOR:

LINE OFF/ON	ON
MODE	REMOTE*

* Preselectors without manual controls, disconnect cable between Preselector and Display Section.

POWER SUPPLY:

POWER	ON
VOLTAGE	4.0 Vdc

SWEEP OSCILLATOR WITH 8692B RF UNIT:

LINE	RF
SWEEP SELECTOR	CW
START/CW	4.0 GHz
FUNCTION	START/STOP
ALC	On

ANALYZER:

BAND	n=2-
FREQUENCY	4.0 GHz

PERFORMANCE TESTS

4-16. Yig Filter Insertion Loss (cont'd)

SCAN WIDTH PER DIVISION	10 MHz
INPUT ATTENUATION	10 dB
BASE LINE CLIPPER	9 o'clock
SCAN TIME PER DIVISION	10 MILLISECONDS
LOG REF LEVEL	-20 dBm
LOG LINEAR	LOG
VIDEO FILTER	OFF
SCAN MODE	INT
SCAN TRIGGER	AUTO
POWER	ON

2. Connect coaxial cable to REMOTE input on Preselector.
3. Connect center conductor of coaxial cable to "+" terminal on Power Supply.
4. Connect outer conductor of coaxial cable to "-" terminal on Power Supply.
5. Connect Sweep Oscillator RF Output to Spectrum Analyzer INPUT.
6. Reduce Spectrum Analyzer SCAN WIDTH PER DIVISION to 1 MHz. Center signal on CRT display with FREQUENCY control.
7. Set SIGNAL IDENTIFIER switch to ON. Perform signal identification to ensure signal displayed is result of n=2- mixing mode. Set SIGNAL IDENTIFIER switch to OFF.
8. Adjust Sweep Oscillator POWER LEVEL and/or Analyzer LOG REF LEVEL Vernier for a convenient signal level.
9. Record signal level. _____ dBm
10. Connect Sweep Oscillator RF output to upper FILTER PORT on Preselector.
11. Install rigid coaxial cable between lower FILTER PORT on Preselector and Spectrum Analyzer INPUT.
12. Adjust Power Supply Vernier voltage control for maximum signal level indication on CRT display.

Note
Tuning rate is critical. The frequency tuning of the Preselector passband is changed at a rate of 1 MHz/mV.
13. Adjust FREQ OFFSET to maximize signal level on CRT display.
14. Record signal level. _____ dBm
15. Subtract level recorded in step 9. - _____ dB
16. Record insertion loss at 4 GHz. _____ dB
17. Repeat the above procedure at selected frequency points to 18 GHz.

PERFORMANCE TESTS

4-17. Limiting Level

SPECIFICATION: (Maximum input level for <1 dB signal compression.) >+5 dBm.

DESCRIPTION: Yig filter compression is checked at the low frequency end of the operating range (point of maximum filter compression). Compression is measured by applying a -5 dBm signal to the filter input; the power level at the filter output is measured to establish a reference level. The input power level is increased by 10 dB and the output level is checked for a corresponding increase. In the actual test, a 10 dB fixed attenuator is switched from between the signal source and filter to the filter output. Using this procedure, any change in output level would be due to compression and not to errors in the measurement test setup.

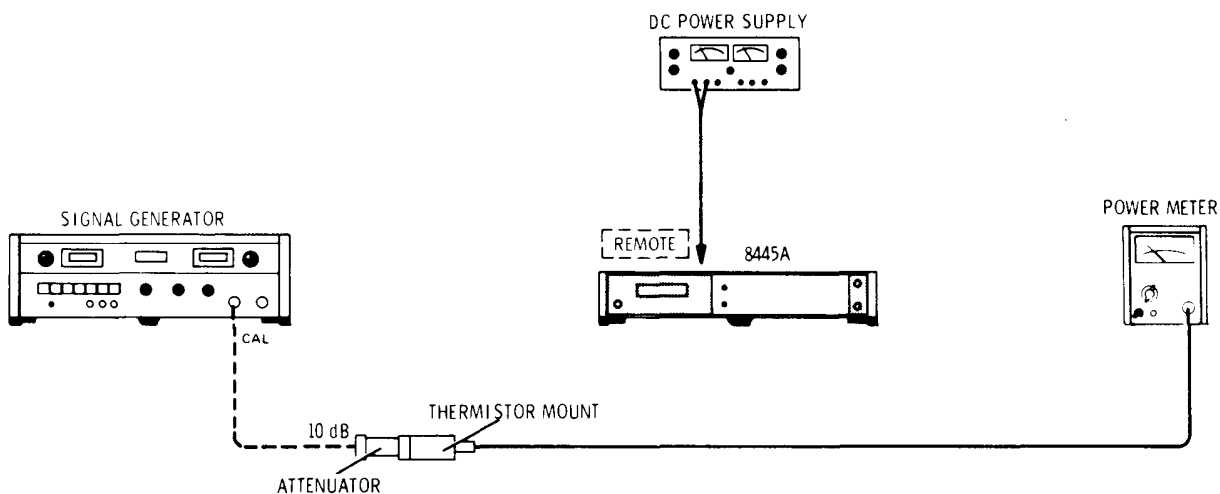

Figure 4-4. Yig Filter Signal Compression Test Setup

EQUIPMENT:

Power Meter	HP 432A
Thermistor Mount	HP 8478B
Power Supply	HP 6205B
Signal Generator	HP 8616B
10-dB Attenuator	HP 8491A

1. Connect test setup as indicated in Figure 4-4 and make the following control settings:

PRESELECTOR:

LINE OFF/ON ON

POWER SUPPLY :

Output Voltage 1.8 Vdc

PERFORMANCE TESTS

4-17. Limiting Level (cont'd)

SIGNAL GENERATOR:

LINE	On
RF	On
ALC	On
FREQUENCY	1800 MHz

POWER METER:

POWER	ON
RANGE	-5 dBm
MOUNT RESISTANCE	200Ω

2. Adjust Signal Generator output level for an indication of -5 dBm on Power Meter.
3. Connect Signal Generator output through the 10 dB attenuator to FILTER PORT on Preselector.
4. Connect Power Meter and Thermistor Mount to second FILTER PORT on Preselector.
5. Adjust Power Supply Fine Voltage control for maximum power level indication on Power Meter.
6. Adjust Preselector FREQ OFFSET control for maximum power level indication on Power Meter.

Note

Indicated power meter level should correspond with the insertion loss indicated on Preselector calibration label. Typically 4 dB below the level established in step 2 above.

7. Note and record level indicated on Power Meter. _____ dBm
8. Remove 10 dB Attenuator from Signal Generator to Preselector path and install in Preselector to Thermistor Mount and Power Meter path.
9. Note and record level indicated on Power Meter. _____ dBm
10. Record compression loss; difference between levels recorded in steps 9 and 7 above. _____ dB

SECTION V ADJUSTMENTS

5-1. INTRODUCTION

5-2. This section describes adjustments required to return the Preselector to peak operating condition when repairs are required. Included in this section are test setups, checks and adjustment procedures. A test card for recording data is included at the back of this section. Adjustment location drawings or photographs are contained in the test setup and/or the component location figures adjacent to the schematic diagrams in Section VIII.

5-3. The adjustment procedures are arranged in numerical order. For best results, this order should be followed. Record data, taken during adjustments, in the spaces provided or on the data test card at the end of this section. Comparison of initial data with data taken during periodic adjustments assists in preventive maintenance and troubleshooting.

5-4. EQUIPMENT REQUIRED

5-5. Each adjustment procedure contains a list of test equipment for that particular test. Table 1-3 contains a tabular list of test equipment and accessories required in the adjustment procedures. In addition, the table contains the required minimum specifications and a suggested manufacturer's model number.

5-6. FACTORY SELECTED COMPONENTS

5-7. Table 8-1 contains a list of factory selected components by reference designation, basis of selection, and schematic diagram location on which the component is illustrated. Factory selected components are designated by an asterisk(*) on the schematic diagrams in Section VIII of this manual.

ADJUSTMENTS

5-8. Power Supplies, Check and Adjustment

REFERENCE: Service Sheet 6.

DESCRIPTION: Power supplies in the Preselector provide regulated outputs of +19.5 and -23 volts and an unregulated output of +40 volts. Only the +19.5 volt supply is adjustable. These checks verify proper operation of the power supplies.

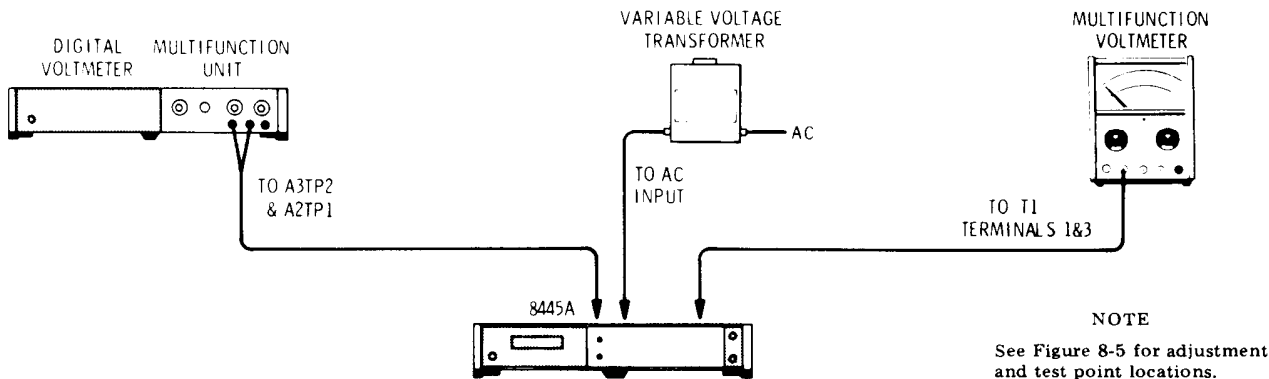

Figure 5-1. Power Supply Check and Adjustment Test Setup

EQUIPMENT:

Digital Voltmeter w/3484A Multifunction Unit	HP 3480B
AC Voltmeter	HP 410C
Variable Voltage Transformer	General Radio W5MT3A

Note

Unless otherwise specified, all dc voltages are measured with respect to test point A3TP2.

ADJUSTMENTS

5-8. Power Supplies, Check and Adjustment (cont'd)

PROCEDURE:

1. Connect test setup as indicated in Figure 5-1.
2. Remove top cover from Preselector and connect digital voltmeter test leads to A2TP1 (+19.5 Vdc) and A3TP2 (signal/reference ground). Connect AC voltmeter to terminals 1 and 3 of power transformer T1.
3. Apply power to Preselector, measure and record the +19.5 volt output. Vary the ac line voltage from 103.5 to 126.5 volts. The +19.5 volt regulated output should not vary more than 20 mV.

AC Input	+19.5 Vdc Output
103.5	_____
115	_____
126.5	_____

4. Set ac line voltage to 115 volts. Adjust A2R5 for 19.5 Vdc \pm 20 mV at A2TP1. Measure and record the dc levels at test points locations listed below.

Location	Normal	Actual
A4 pin 1	+40 Vdc*	_____
A2 pins 9/K	-23 Vdc \pm 10%	_____

Note

The +40 Vdc supply will vary from approximately +40 with the Yig Filter tuned to 2 GHz to +30 Vdc at 18 GHz.

5. If the dc supplies are out of tolerance, refer to Service Sheet 6 for trouble isolation procedure.
-

5-9. Pre-Driver Checks and Adjustments

REFERENCE: Service Sheet 3.

DESCRIPTION: With the Preselector connected to the Spectrum Analyzer, the Pre-Driver is checked and adjusted for an output voltage that tracks the tuning response of the Spectrum Analyzer. Operational amplifiers A1U1, A1U2 and A1U3 are adjusted for null and checked for correct gain. (Gain controlled by fixed precision resistors.) Resistors A2R26 and A2R28 are adjusted for an offset voltage corresponding to 550 or 2050 MHz first IF of the Spectrum Analyzer. All voltage measurements are made referenced to ground test point A3TP2.

ADJUSTMENTS

5-9. Pre-Driver Checks and Adjustments (cont'd)

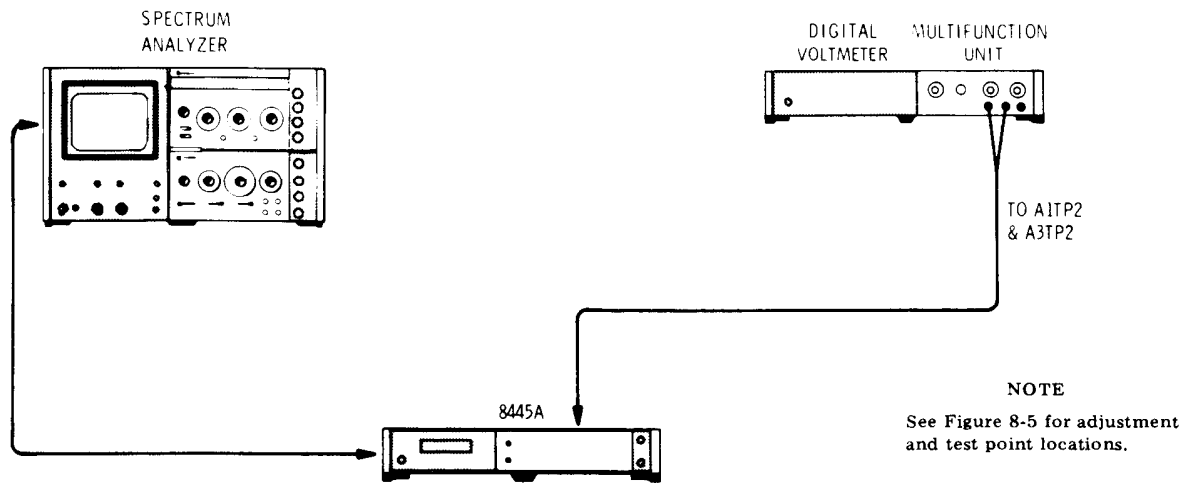

Figure 5-2. Pre-Driver Check and Adjustment Test Setup

EQUIPMENT:

Spectrum Analyzer	HP 8555A/8552/141T
Digital Voltmeter with 3484A Multifunction Unit	HP 3480B

Note

Unless otherwise specified, all dc voltages are measured with respect to ground test point A3TP2.

1. Connect test setup as indicated in Figure 5-2.
2. Apply power to both Preselector and Spectrum Analyzer. Allow at least 30 minutes for equipment stabilization.
3. Set Spectrum Analyzer controls as follows:

BAND	n= 2-
SCAN WIDTH PER DIVISION	1 MHz
SCAN WIDTH	ZERO
INPUT ATTENUATION	10 dB
SCAN TIME PER DIVISION	10 MILLISECONDS
SCAN MODE	INT
SCAN TRIGGER	AUTO
LOG/LINEAR	LOG
LOG REFERENCE LEVEL	-10 dBm

4. Set switch A1S1 to TEST position.
5. Set switch A3S1 to TEST position.
6. Connect digital voltmeter to test point A1TP2 and common ground point A3TP2.
7. Adjust A1R8 for null indication.

Test limits 0.00 ±0.2 mV
Record level _____

ADJUSTMENTS

5-9. Pre-Driver Checks and Adjustments (cont'd)

8. Connect digital voltmeter to test point A1TP4.

9. Adjust A1R23 for null indication.

Test limits 0.00 ± 0.2 mV
Record level _____

10. Connect digital voltmeter to test point A1TP3.

11. Adjust A1R31 for null indication.

Test limits 0.00 ± 0.2 mV
Record level _____

12. Set switch A3S1 to OPR position.

13. Adjust A1R26 for +2.000 volts at test point A1TP3.

Test limits $+2.000 \pm .002$ V
Record level _____

14. Set Spectrum Analyzer BAND to n=2+.

15. Verify that voltage level at test point A1TP3 is -2.000 volts.

Test limits $-2.000 \pm .002$ V
Record level _____

16. Set Spectrum Analyzer BAND to n=1+* (550 MHz IF). Adjust A1R28 for -536.6 mV at test point A1TP3.

Test limits -536.6 ± 2.0 mV
Record level _____

17. Set Spectrum Analyzer BAND to n=1-* (550 MHz IF).

18. Verify that voltage level at test point A1TP3 is +536.6 mV.

Test limits $+536.6 \pm 2.0$ mV
Record level _____

19. Set Spectrum Analyzer BAND to n=1-(2.05 GHz IF).

20. Set switch A1S1 to OPR position.

21. Set switch A3S1 to TEST position.

22. Adjust Spectrum Analyzer FREQUENCY control for an indicated voltage level of -3.000 volts at test point A1TP3.

23. Check and record the voltage level for each of the FREQUENCY BANDS below.

FREQUENCY BAND	Test Limits Vdc	Record Level
n=1+	$-3.000 \pm .002$	_____
n=2-	$-6.000 \pm .003$	_____
n=2+	$-6.000 \pm .003$	_____
n=3-	$-9.000 \pm .004$	_____
n=3+	$-9.000 \pm .004$	_____
n=4-	$-12.000 \pm .005$	_____
n=4+	$-12.000 \pm .005$	_____

ADJUSTMENTS

5-9. Pre-Driver Checks and Adjustments (cont'd)

24. If voltage levels are *not* within tolerances, repeat test procedure. Refer to Service Sheet 3 for troubleshooting procedure.
25. Set switch A3S1 to OPR position.

5-10. Remote Amplifier Check and Adjustment

REFERENCE: Service Sheet 5.

DESCRIPTION: The remote amplifier A2U3 is adjusted for null, common-mode and differential-mode. The adjustments are repeated until settings are found that satisfy null, common-mode and differential-mode requirements.

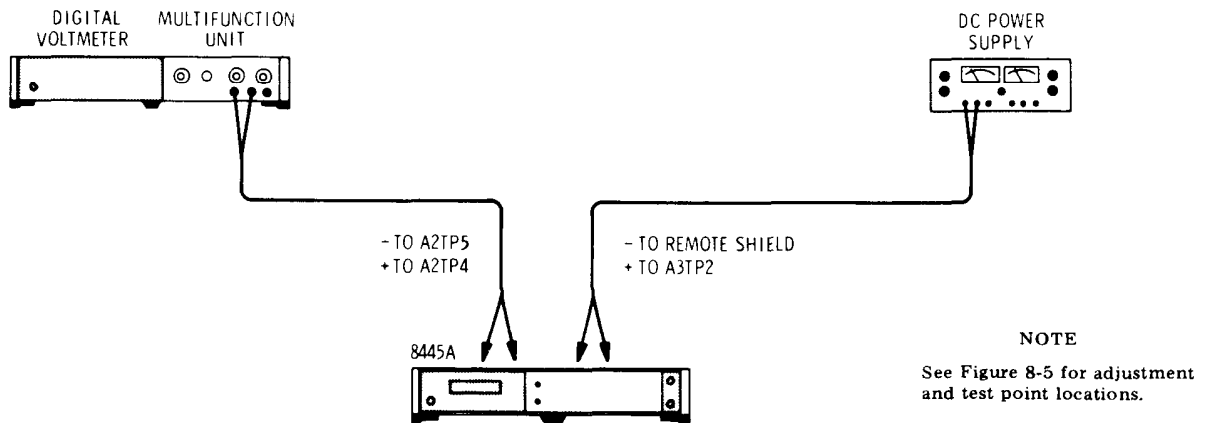

Figure 5-3. Remote Amplifier Check and Adjustment Test Setup

EQUIPMENT:

Power Supply (0 to 10 Vdc)	HP 6205B
Coaxial Cable (BNC to alligator clips)	HP 10501A
Four foot test leads with alligator clips (2 each)	
Digital Voltmeter with 3484A Multifunction Unit	HP 3480B

1. With test setup as indicated in Figure 5-3, apply power to Preselector and allow at least 30 minutes for equipment to stabilize.
2. Connect “+” terminal of power supply to A3TP2.
3. Connect “-” terminal of power supply to REMOTE connector shield.
4. Connect “+” terminal of digital voltmeter to A2TP4.
5. Connect “-” terminal of digital voltmeter to A2TP5.
6. Set power supply output voltage to zero.

ADJUSTMENTS

5-10. Remote Amplifier Check and Adjustment (cont'd)

7. Adjust A2R23 NULL for zero indication on digital voltmeter.
8. Common-mode adjustment:
 - a. Set power supply output voltage to 10 volts.
 - b. Note error voltage indicated by voltmeter.
 - c. Alternately adjust A2R20 and A2R21 for a zero indication on voltmeter. Remove about half the error voltage with each potentiometer.
9. Differential-mode adjustment:
 - a. Set power supply output voltage to zero.
 - b. Connect REMOTE connector center conductor to "+" terminal of power supply.
 - c. Connect "-" terminal of digital voltmeter to A2TP2.
 - d. Adjust A2R23 NULL for zero indication on voltmeter.
 - e. Set Power Supply output voltage to 10 volts.
 - f. Alternately adjust A2R20 and A2R21 for zero indication on voltmeter, removing about half the error voltage with each potentiometer.
10. Repeat steps 2 through 9 until settings are found which simultaneously satisfy all modes within a tolerance of ± 1.0 millivolts.
11. Note and record digital voltmeter indication for each mode.

Common-mode _____ mV
Differential-mode _____ mV

5-11. Yig Driver Adjustments (Matched Operation)

REFERENCE: Service Sheet 4.

Note

This procedure is used to match Preselector with a particular 8555A Spectrum Analyzer. For Preselector operation with different Spectrum Analyzers, perform adjustment procedure listed in paragraph 5-12. (See paragraph 3-23 for improvement in Spectrum Analyzer adjustments prior to performing the adjustment procedure below.)

DESCRIPTION: The Yig Driver is adjusted to tune the Yig Filter to track the tuning response of the Spectrum Analyzer. Operational amplifier A3U1 is adjusted for null. Front panel adjustments are performed to provide correct frequency offset and tracking. The Yig linearity correction breakpoints are adjusted to compensate for saturation in the Yig core at the higher frequencies.

ADJUSTMENTS

5-11. Yig Driver Adjustments (Matched Operation) (cont'd)

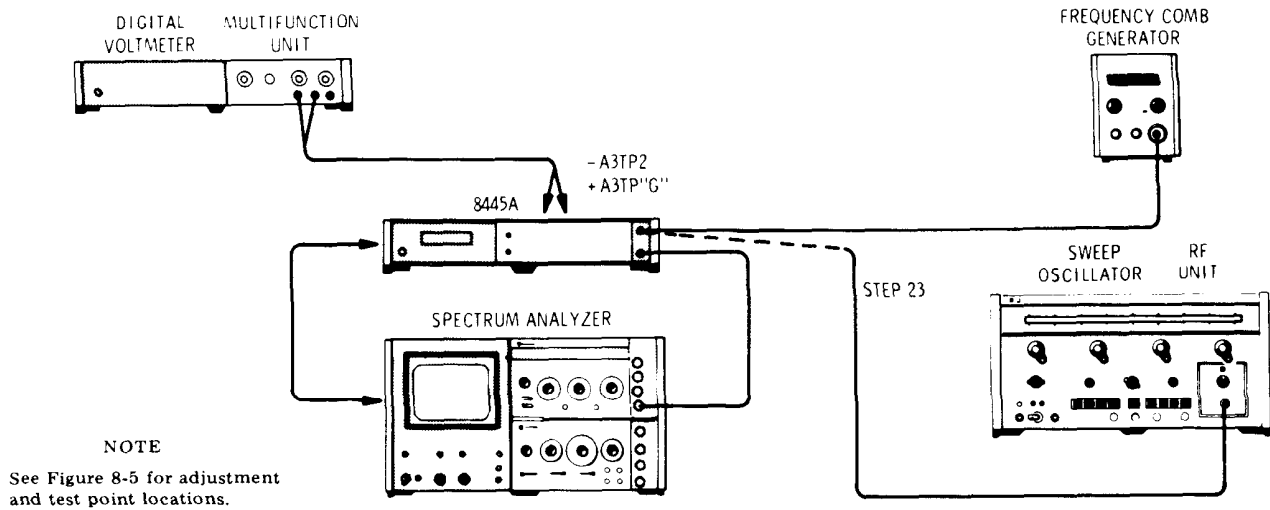

Figure 5-4. Yig Driver Check and Adjustment Test Setup (Matched Operation)

EQUIPMENT:

Spectrum Analyzer	HP 8555A/8552/141T
Sweep Oscillator	HP 8690B
RF Unit	HP 8695A
Comb Generator	HP 8406A
Digital Voltmeter with 3484A Multifunction Unit	HP 3480B
Four-foot test leads with alligator clips (2 each)	

1. With test setup as indicated in Figure 5-4, apply power to Preselector and Spectrum Analyzer. Allow at least 30 minutes for equipment to stabilize.

Note

Perform the Power Supply and Pre-Driver Check and Adjustment Procedures prior to performing the Yig Driver adjustments.

2. Center FREQ OFFSET control R1. Remove fuse A3F1. Disconnect interconnect cable between Preselector and Spectrum Analyzer.
3. Connect a jumper between test points A3TP3 and A3TP'G' (anode of A3CR3).
4. Connect a jumper between test points A3TP2 and A3TP4.
5. Connect "-" terminal of digital voltmeter to test point A3TP2.
6. Connect "+" terminal of digital voltmeter to test point A3TP'G'.
7. Adjust A3R7 for zero indication on digital voltmeter.
8. Remove jumpers installed in steps 3 and 4 above.
9. Disconnect digital voltmeter and install fuse A3F1.

ADJUSTMENTS

5-11. Yig Driver Adjustments (Matched Operation) (cont'd)

10. Install interconnect cable between Preselector and Spectrum Analyzer.
11. Connect rigid coaxial cable between lower FILTER PORT on Preselector and RF Section INPUT.
12. Set Spectrum Analyzer controls as follows:

BAND	n=1— (550 MHz IF)
FREQUENCY	2 GHz
SCAN WIDTH	PER DIVISION
SCAN WIDTH PER DIVISION	10 MHz
BANDWIDTH	300 kHz
INPUT ATTENUATION	10 dB
SCAN TIME PER DIVISION	10 MILLISECONDS
LOG/LINEAR	LOG
LOG REF LEVEL	-30 dBm
SCAN MODE	INT
SCAN TRIGGER	AUTO

13. Connect Comb Generator (adjusted for maximum 100 MHz comb signals) to upper Preselector FILTER PORT.
14. Tune Spectrum Analyzer FREQUENCY control to center the 2 GHz comb signal on the CRT display.
15. Reduce SCAN WIDTH PER DIVISION to .2 MHz keeping signal centered on display with FREQUENCY control.
16. Reduce SCAN WIDTH PER DIVISION to 100 kHz; center signal on display with FINE TUNE control.
17. Adjust Preselector FREQ OFFSET control to maximize signal on CRT display.
18. Set SCAN WIDTH PER DIVISION to 100 MHz.
19. Select n=2+ BAND and tune Spectrum Analyzer to 8 GHz.
20. Repeat steps 15 and 16.
21. Adjust Preselector TRACKING control to maximize signal on CRT display.
22. Repeat steps 14 through 21.

Note

A3R5 factory selected to set center range of TRACKING control R2. Null adjustment
A3R7 may be adjusted to set center range of FREQ OFFSET control R1.

23. Connect Sweep Oscillator RF Unit output to upper FILTER PORT on Preselector.
 24. Set Spectrum Analyzer controls as follows: SCAN WIDTH PER DIVISION to 10 MHz, BAND to n=4+, and FREQUENCY to 12.5 GHz.
 25. Adjust Sweep Oscillator and RF Unit for a 12.5 GHz signal at a power output level of -20 dBm, centered on CRT display.
 26. Adjust A3R24 to maximize signal on CRT display.
-

ADJUSTMENTS

5-11. Yig Driver Adjustments (Matched Operation) (cont'd)

27. Tune Spectrum Analyzer and Sweep Oscillator to 15.5 GHz.
28. Adjust A3R4 to maximize signal on CRT display.
29. Tune Spectrum Analyzer and Sweep Oscillator to 18 GHz.
30. Adjust A3R21 to maximize signal on CRT display.
31. Repeat steps 25 through 30.

5-12. Yig Driver Adjustments (Linear Operation)

REFERENCE: Service Sheet 4.

Note

This procedure aligns the Preselector for linear operation. Use this procedure when the Preselector is to be used with different Spectrum Analyzers. See paragraph 5-11 Yig Driver Adjustment for Matched Operation. (See paragraph 3-23 for improvement in Spectrum Analyzer adjustments prior to performing the adjustment procedure below.)

DESCRIPTION: The Yig Driver is adjusted for linear frequency tracking with voltage. Operational amplifier A3U1 is adjusted for null. Front panel controls are adjusted to provide correct frequency offset and tracking. The Yig linearity correction breakpoints are adjusted to tune the filter bandpass to fixed frequency points for fixed input voltages. The linearity breakpoints compensate for saturation in the Yig core at the higher frequencies.

ADJUSTMENTS

5-12. Yig Driver Adjustments (Linear Operation) (cont'd)

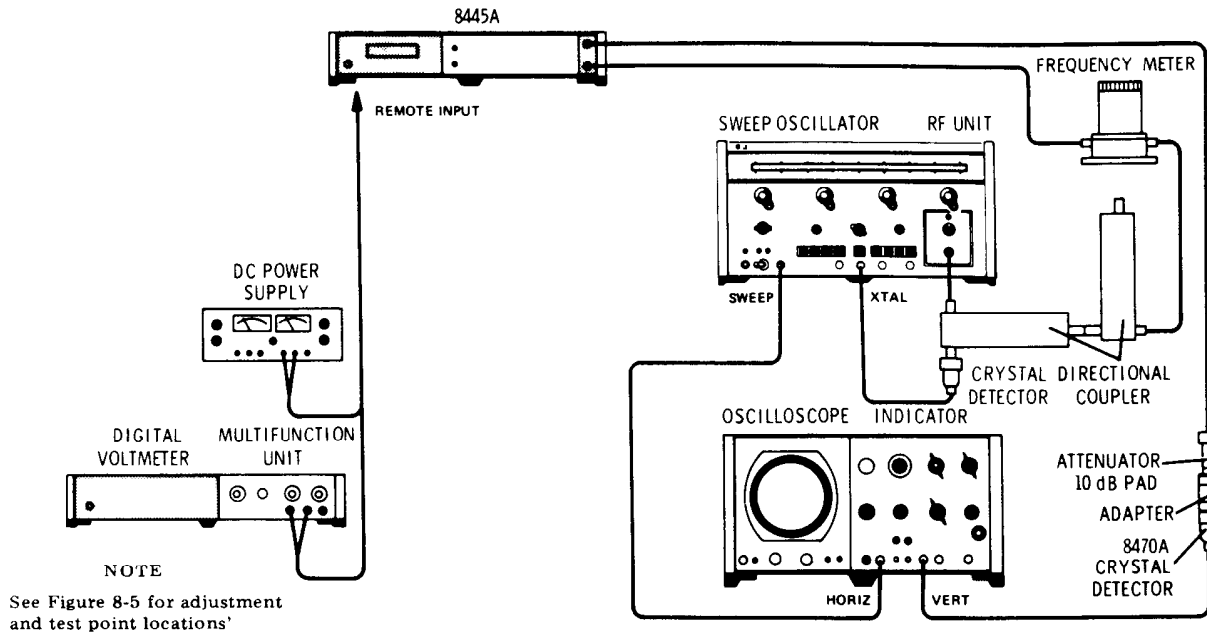

Figure 5-5. Yig Driver Check and Adjustment Test Setup (Linear Operation)

EQUIPMENT:

Sweep Oscillator	HP 8690B
RF Unit	HP 8692B
RF Unit	HP 8694B
RF Unit	HP 8695A
Swept Frequency Indicator	HP 1416A
Oscilloscope/Display Section	HP 140 Series
Power Supply	HP 6205B
Frequency Meter	HP 536A
Frequency Meter	HP 537A
Frequency Meter	HP P532A
Digital Voltmeter with 3484A Multifunction Unit	HP 3480B
Directional Coupler (2 each)	HP 779D
Crystal Detector	HP 8470A
Coaxial Attenuator, 10 dB	HP 8491B
Crystal Detector	HP 423A
Adapter APC-7 to Type N male	HP 11525A

1. Connect test setup as indicated in Figure 5-5. Apply power and allow at least 30 minutes for equipment to stabilize.

Note

Perform the Power Supply and Pre-Driver Check and Adjustment Procedures prior to performing the Yig Driver Adjustments (Linear Operation).

ADJUSTMENTS

5-12. Yig Driver Adjustments (Linear Operation) (cont'd)

2. Set controls as follows:

PRESELECTOR:
(Remote Operation)

MODE REMOTE

SWEEP OSCILLATOR (8690B/8692B):

START/CW 2.0 GHz
 STOP/ Δ F 4.0 GHz
 SWEEP SELECTOR AUTO
 SWEEP TIME 10-1
 SWEEP TIME Vernier LINE SYNC
 FUNCTION Δ F
 POWER LEVEL 4

POWER SUPPLY:

VOLTAGE 2.000 \pm .001 Vdc

Note

Make all Power Supply voltage adjustments by first setting voltage output to 0 volt and approaching set level in a positive-going direction. This reduces the effects of hysteresis in the magnetic core structure.

SWEPT FREQUENCY INDICATOR:

MODE LOG
 SENSITIVITY 5 dB/CM
 BANDWIDTH HIGH
 ATTENUATION/DB 0

3. Adjust REFERENCE SET on Swept Frequency Indicator to position trace on upper third of CRT display.
4. Adjust Frequency Meter for 2.0 GHz. Note dip in display indicating 2 GHz frequency point.
5. Adjust FREQ OFFSET control to center Preselector passband at 2.0 GHz.
6. Replace Sweep Oscillator 8692B RF Unit with 8694B RF Unit.
7. Tune Sweep Oscillator to 8.0 GHz with START/CW control.
8. Replace Frequency Meter HP 536A with HP 537A. Tune Frequency Meter to 8.0 GHz.
9. Adjust Power Supply output voltage for 8.000 \pm .002 Vdc.
10. Adjust Preselector TRACKING control to center passband at 8.0 GHz.
11. Repeat passband adjustments for 2.0 and 8.0 GHz.
12. Replace Sweep Oscillator 8694B RF Unit with 8695A RF Unit.

ADJUSTMENTS

5-12. Yig Driver Adjustments (Linear Operation) (cont'd)

13. Tune Sweep Oscillator to 12.5 GHz with START/CW control.
14. Replace Frequency Meter HP 537A with HP P532A. Tune Frequency Meter to 12.5 GHz.
15. Adjust Power Supply output voltage for $12.500 \pm .002$ Vdc.
16. Adjust A3R29 to center Preselector passband at 12.5 GHz.
17. Tune Sweep Oscillator and Frequency Meter to 15.5 GHz.
18. Adjust Power Supply output voltage to 15.50 Vdc.
19. Adjust A3R24 to center Preselector passband at 15.5 GHz.
20. Tune Sweep Oscillator and Frequency Meter to 18.0 GHz.
21. Adjust Power Supply output voltage to 18.00 Vdc.
22. Adjust A3R21 to center Preselector passband at 18.0 GHz.
23. Repeat steps 13 through 22.

Table 5-1. Check and Adjustment Test Card

Hewlett-Packard Model 8445A Preselector Instrument's Serial No. 8445A: _____ 8555A: _____ 8552 : _____ 140 : _____		Test Performed by _____ Date _____				
Para. No.	Test Description	Measurement Unit	Min	Actual	Max	
5-8.	Power Supplies, Check and Adjustment					
	+19.5 Vdc supply	Vdc	+19.48	_____	+19.52	
	-23 Vdc supply	Vdc	-20.7	_____	-25.3	
	+40 Vdc supply	Vdc	+30*	_____	+40*	
	*Unregulated supply: voltage level determined by load and line voltage.					
5-9.	Pre-Driver, Check and Adjustment					
	A1R8 NULL ADJ 1	mV	-0.2	_____	+0.2	
	A1R23 NULL ADJ 2	mV	-0.2	_____	+0.2	
	A1R31 NULL ADJ 3	mV	-0.2	_____	+0.2	
	A1R26 ADJ 4 2050 MHz IF n=2+	Vdc	-1.998	_____	-2.002	
	A1R28 ADJ 5 550 MHz IF n=1-*	mV	+ 534.6	_____	+ 538.6	
	Check n=1+ *	mV	-534.6	_____	-538.6	
	Set BAND to n=1-, A1S1 to OPR, and A3S1 to TEST					
	Adjust FREQUENCY for -3.000 at A1TP3. Check level at A1TP3 for following BANDS.					
	n=1+	Vdc	-2.998	_____	-3.002	
	n=2-	Vdc	-5.997	_____	-6.003	
	n=2+	Vdc	-5.997	_____	-6.003	
	n=3-	Vdc	-8.996	_____	-9.004	
n=3+	Vdc	-8.996	_____	-9.004		
n=4-	Vdc	-11.995	_____	-12.005		
n=4+	Vdc	-11.995	_____	-12.005		
5-10	Remote Amplifier, Check and Adjustment					
	Common-mode	mV	-1.0	_____	+1.0	
	Differential-mode	mV	-1.0	_____	+1.0	

Table 5-1. Check and Adjustment Test Card (cont'd)

Para. No.	Test Description	Measurement Unit	Min	Actual	Max
5-11.	Yig Driver, Check and Adjustment (Matched Operation) A3R7 NULL ADJ FREQ OFFSET R1 2 GHz TRACKING R2 8 GHz Breakpoint A3R29 12.5 GHz Breakpoint A3R24 15.5 GHz Breakpoint A3R21 18.0 GHz	Date mV Max Max Max Max Max	-2.0	_____ _____	+2.0
5-12.	Yig Driver, Check and Adjustment (Linear Operation) FREQ OFFSET Adj TRACKING Adj A3R29 Adj A3R24 Adj A3R21 Adj	Date GHz GHz GHz GHz GHz		_____ _____ _____ _____ _____	

SECTION VI REPLACEABLE PARTS

6-1. INTRODUCTION

6-2. Table 6-1 is an index of reference designations and abbreviations used in Hewlett-Packard manuals.

6-3. Table 6-2 lists 8445A replaceable parts in alpha-numerical order of their reference designation.

6-4. Table 6-3 lists code number identification of manufacturers. (Manufacturer's code and part number are supplied for each part listed in Table 6-3).

6-5. ORDERING INFORMATION

6-6. To obtain replacement parts, address order or inquiry to your local HP Sales and Service office (see list at rear of manual for address). Identify parts by their HP part number.

6-7. To obtain a part that is not listed, include:

- a. Instrument model number.
- b. Instrument serial number.
- c. Description of the part.
- d. Function and location of the part.

Table 6-1. Reference Designators and Abbreviations used in Parts List

REFERENCE DESIGNATORS																																																																																																																																																																																																																																																													
<table style="width: 100%; border: none;"> <tr><td>A</td><td>= assembly</td></tr> <tr><td>B</td><td>= motor</td></tr> <tr><td>BT</td><td>= battery</td></tr> <tr><td>C</td><td>= capacitor</td></tr> <tr><td>CP</td><td>= coupler</td></tr> <tr><td>CR</td><td>= diode</td></tr> <tr><td>DL</td><td>= delay line</td></tr> <tr><td>DS</td><td>= device signaling (lamp)</td></tr> <tr><td>E</td><td>= misc electronic part</td></tr> </table>	A	= assembly	B	= motor	BT	= battery	C	= capacitor	CP	= coupler	CR	= diode	DL	= delay line	DS	= device signaling (lamp)	E	= misc electronic part	<table style="width: 100%; border: none;"> <tr><td>F</td><td>= fuse</td></tr> <tr><td>FL</td><td>= Filter</td></tr> <tr><td>J</td><td>= jack</td></tr> <tr><td>K</td><td>= relay</td></tr> <tr><td>L</td><td>= inductor</td></tr> <tr><td>LS</td><td>= loud speaker</td></tr> <tr><td>M</td><td>= meter</td></tr> <tr><td>MK</td><td>= microphone</td></tr> <tr><td>MP</td><td>= mechanical part</td></tr> </table>	F	= fuse	FL	= Filter	J	= jack	K	= relay	L	= inductor	LS	= loud speaker	M	= meter	MK	= microphone	MP	= mechanical part	<table style="width: 100%; border: none;"> <tr><td>P</td><td>= plug</td></tr> <tr><td>Q</td><td>= transistor</td></tr> <tr><td>R</td><td>= resistor</td></tr> <tr><td>RT</td><td>= thermistor</td></tr> <tr><td>S</td><td>= switch</td></tr> <tr><td>T</td><td>= transformer</td></tr> <tr><td>TB</td><td>= terminal board</td></tr> <tr><td>TP</td><td>= test point</td></tr> <tr><td>U</td><td>= integrated circuit</td></tr> </table>	P	= plug	Q	= transistor	R	= resistor	RT	= thermistor	S	= switch	T	= transformer	TB	= terminal board	TP	= test point	U	= integrated circuit	<table style="width: 100%; border: none;"> <tr><td>V</td><td>= vacuum tube, neon bulb, photocell, etc.</td></tr> <tr><td>VR</td><td>= voltage regulator</td></tr> <tr><td>W</td><td>= cable</td></tr> <tr><td>X</td><td>= socket</td></tr> <tr><td>Y</td><td>= crystal</td></tr> <tr><td>Z</td><td>= tuned cavity, network</td></tr> </table>	V	= vacuum tube, neon bulb, photocell, etc.	VR	= voltage regulator	W	= cable	X	= socket	Y	= crystal	Z	= tuned cavity, network																																																																																																																																																																																								
A	= assembly																																																																																																																																																																																																																																																												
B	= motor																																																																																																																																																																																																																																																												
BT	= battery																																																																																																																																																																																																																																																												
C	= capacitor																																																																																																																																																																																																																																																												
CP	= coupler																																																																																																																																																																																																																																																												
CR	= diode																																																																																																																																																																																																																																																												
DL	= delay line																																																																																																																																																																																																																																																												
DS	= device signaling (lamp)																																																																																																																																																																																																																																																												
E	= misc electronic part																																																																																																																																																																																																																																																												
F	= fuse																																																																																																																																																																																																																																																												
FL	= Filter																																																																																																																																																																																																																																																												
J	= jack																																																																																																																																																																																																																																																												
K	= relay																																																																																																																																																																																																																																																												
L	= inductor																																																																																																																																																																																																																																																												
LS	= loud speaker																																																																																																																																																																																																																																																												
M	= meter																																																																																																																																																																																																																																																												
MK	= microphone																																																																																																																																																																																																																																																												
MP	= mechanical part																																																																																																																																																																																																																																																												
P	= plug																																																																																																																																																																																																																																																												
Q	= transistor																																																																																																																																																																																																																																																												
R	= resistor																																																																																																																																																																																																																																																												
RT	= thermistor																																																																																																																																																																																																																																																												
S	= switch																																																																																																																																																																																																																																																												
T	= transformer																																																																																																																																																																																																																																																												
TB	= terminal board																																																																																																																																																																																																																																																												
TP	= test point																																																																																																																																																																																																																																																												
U	= integrated circuit																																																																																																																																																																																																																																																												
V	= vacuum tube, neon bulb, photocell, etc.																																																																																																																																																																																																																																																												
VR	= voltage regulator																																																																																																																																																																																																																																																												
W	= cable																																																																																																																																																																																																																																																												
X	= socket																																																																																																																																																																																																																																																												
Y	= crystal																																																																																																																																																																																																																																																												
Z	= tuned cavity, network																																																																																																																																																																																																																																																												
ABBREVIATIONS																																																																																																																																																																																																																																																													
<table style="width: 100%; border: none;"> <tr><td>A</td><td>= amperes</td></tr> <tr><td>AFC</td><td>= automatic frequency control</td></tr> <tr><td>AMPL</td><td>= amplifier</td></tr> <tr><td>BFO</td><td>= beat frequency oscillator</td></tr> <tr><td>BE CU</td><td>= beryllium copper</td></tr> <tr><td>BH</td><td>= binder head</td></tr> <tr><td>BP</td><td>= bandpass</td></tr> <tr><td>BRS</td><td>= brass</td></tr> <tr><td>BWO</td><td>= backward wave oscillator</td></tr> <tr><td>CCW</td><td>= counterclockwise</td></tr> <tr><td>CER</td><td>= ceramic</td></tr> <tr><td>CMO</td><td>= cabinet mount only</td></tr> <tr><td>COEF</td><td>= coefficient</td></tr> <tr><td>COM</td><td>= common</td></tr> <tr><td>COMP</td><td>= composition</td></tr> <tr><td>COMPL</td><td>= complete</td></tr> <tr><td>CONN</td><td>= connector</td></tr> <tr><td>CP</td><td>= cadmium plate</td></tr> <tr><td>CRT</td><td>= cathode-ray tube</td></tr> <tr><td>CW</td><td>= clockwise</td></tr> <tr><td>DEPC</td><td>= deposited carbon</td></tr> <tr><td>DR</td><td>= drive</td></tr> <tr><td>ELECT</td><td>= electrolytic</td></tr> <tr><td>ENCAP</td><td>= encapsulated</td></tr> <tr><td>EXT</td><td>= external</td></tr> <tr><td>F</td><td>= farads</td></tr> <tr><td>FH</td><td>= flat head</td></tr> <tr><td>FIL H</td><td>= Fillister head</td></tr> <tr><td>FXD</td><td>= fixed</td></tr> <tr><td>G</td><td>= giga (10⁹)</td></tr> <tr><td>GE</td><td>= germanium</td></tr> <tr><td>GL</td><td>= glass</td></tr> <tr><td>GRD</td><td>= ground(ed)</td></tr> </table>	A	= amperes	AFC	= automatic frequency control	AMPL	= amplifier	BFO	= beat frequency oscillator	BE CU	= beryllium copper	BH	= binder head	BP	= bandpass	BRS	= brass	BWO	= backward wave oscillator	CCW	= counterclockwise	CER	= ceramic	CMO	= cabinet mount only	COEF	= coefficient	COM	= common	COMP	= composition	COMPL	= complete	CONN	= connector	CP	= cadmium plate	CRT	= cathode-ray tube	CW	= clockwise	DEPC	= deposited carbon	DR	= drive	ELECT	= electrolytic	ENCAP	= encapsulated	EXT	= external	F	= farads	FH	= flat head	FIL H	= Fillister head	FXD	= fixed	G	= giga (10 ⁹)	GE	= germanium	GL	= glass	GRD	= ground(ed)	<table style="width: 100%; border: none;"> <tr><td>H</td><td>= henries</td></tr> <tr><td>HDW</td><td>= hardware</td></tr> <tr><td>HEX</td><td>= hexagonal</td></tr> <tr><td>HG</td><td>= mercury</td></tr> <tr><td>HR</td><td>= hour(s)</td></tr> <tr><td>Hz</td><td>= Hertz</td></tr> <tr><td>IF</td><td>= intermediate freq</td></tr> <tr><td>IMPG</td><td>= impregnated</td></tr> <tr><td>INCD</td><td>= incandescent</td></tr> <tr><td>INCL</td><td>= include(s)</td></tr> <tr><td>INS</td><td>= insulation(ed)</td></tr> <tr><td>INT</td><td>= internal</td></tr> <tr><td>K</td><td>= kilo = 1000</td></tr> <tr><td>LH</td><td>= left hand</td></tr> <tr><td>LIN</td><td>= linear taper</td></tr> <tr><td>LK WASH</td><td>= lock washer</td></tr> <tr><td>LOG</td><td>= logarithmic taper</td></tr> <tr><td>LPF</td><td>= low pass filter</td></tr> <tr><td>M</td><td>= milli = 10⁻³</td></tr> <tr><td>MEG</td><td>= meg = 10⁶</td></tr> <tr><td>MET FLM</td><td>= metal film</td></tr> <tr><td>MET OX</td><td>= metallic oxide</td></tr> <tr><td>MFR</td><td>= manufacturer</td></tr> <tr><td>MHz</td><td>= mega Hertz</td></tr> <tr><td>MINAT</td><td>= miniature</td></tr> <tr><td>MOM</td><td>= momentary</td></tr> <tr><td>MOS</td><td>= metalized substrate</td></tr> <tr><td>MTG</td><td>= mounting</td></tr> <tr><td>MY</td><td>= "mylar"</td></tr> <tr><td>N</td><td>= nano (10⁻⁹)</td></tr> <tr><td>N/C</td><td>= normally closed</td></tr> <tr><td>NE</td><td>= neon</td></tr> <tr><td>NI PL</td><td>= nickel plate</td></tr> </table>	H	= henries	HDW	= hardware	HEX	= hexagonal	HG	= mercury	HR	= hour(s)	Hz	= Hertz	IF	= intermediate freq	IMPG	= impregnated	INCD	= incandescent	INCL	= include(s)	INS	= insulation(ed)	INT	= internal	K	= kilo = 1000	LH	= left hand	LIN	= linear taper	LK WASH	= lock washer	LOG	= logarithmic taper	LPF	= low pass filter	M	= milli = 10 ⁻³	MEG	= meg = 10 ⁶	MET FLM	= metal film	MET OX	= metallic oxide	MFR	= manufacturer	MHz	= mega Hertz	MINAT	= miniature	MOM	= momentary	MOS	= metalized substrate	MTG	= mounting	MY	= "mylar"	N	= nano (10 ⁻⁹)	N/C	= normally closed	NE	= neon	NI PL	= nickel plate	<table style="width: 100%; border: none;"> <tr><td>N/O</td><td>= normally open</td></tr> <tr><td>NOM</td><td>= nominal</td></tr> <tr><td>NPO</td><td>= negative positive zero (zero temperature coef-ficient)</td></tr> <tr><td>NPN</td><td>= negative-positive-negative</td></tr> <tr><td>NRFR</td><td>= not recommended for field re-placement</td></tr> <tr><td>NSR</td><td>= not separately replaceable</td></tr> <tr><td>OBD</td><td>= order by description</td></tr> <tr><td>OH</td><td>= oval head</td></tr> <tr><td>OX</td><td>= oxide</td></tr> <tr><td>P</td><td>= peak</td></tr> <tr><td>PC</td><td>= printed circuit</td></tr> <tr><td>PF</td><td>= picofarads = 10⁻¹² farads</td></tr> <tr><td>PH BRZ</td><td>= phosphor bronze</td></tr> <tr><td>PHL</td><td>= Phillips</td></tr> <tr><td>PIV</td><td>= peak inverse voltage</td></tr> <tr><td>PNP</td><td>= positive-negative-positive</td></tr> <tr><td>P/O</td><td>= part of</td></tr> <tr><td>POLY</td><td>= polystyrene</td></tr> <tr><td>PORC</td><td>= porcelain</td></tr> <tr><td>POS</td><td>= position(s)</td></tr> <tr><td>POT</td><td>= potentiometer</td></tr> <tr><td>PP</td><td>= peak-to-peak</td></tr> <tr><td>PT</td><td>= point</td></tr> <tr><td>PWV</td><td>= peak working volt-age</td></tr> <tr><td>RECT</td><td>= rectifier</td></tr> <tr><td>RF</td><td>= radio frequency</td></tr> <tr><td>RH</td><td>= round head or right hand</td></tr> </table>	N/O	= normally open	NOM	= nominal	NPO	= negative positive zero (zero temperature coef-ficient)	NPN	= negative-positive-negative	NRFR	= not recommended for field re-placement	NSR	= not separately replaceable	OBD	= order by description	OH	= oval head	OX	= oxide	P	= peak	PC	= printed circuit	PF	= picofarads = 10 ⁻¹² farads	PH BRZ	= phosphor bronze	PHL	= Phillips	PIV	= peak inverse voltage	PNP	= positive-negative-positive	P/O	= part of	POLY	= polystyrene	PORC	= porcelain	POS	= position(s)	POT	= potentiometer	PP	= peak-to-peak	PT	= point	PWV	= peak working volt-age	RECT	= rectifier	RF	= radio frequency	RH	= round head or right hand	<table style="width: 100%; border: none;"> <tr><td>RMO</td><td>= rack mount only</td></tr> <tr><td>RMS</td><td>= root-mean square</td></tr> <tr><td>RWV</td><td>= reverse working voltage</td></tr> <tr><td>S-B</td><td>= slow-blow</td></tr> <tr><td>SCR</td><td>= screw</td></tr> <tr><td>SE</td><td>= selenium</td></tr> <tr><td>SECT</td><td>= section(s)</td></tr> <tr><td>SEMICON</td><td>= semiconductor</td></tr> <tr><td>SI</td><td>= silicon</td></tr> <tr><td>SIL</td><td>= silver</td></tr> <tr><td>SL</td><td>= slide</td></tr> <tr><td>SPG</td><td>= spring</td></tr> <tr><td>SPL</td><td>= special</td></tr> <tr><td>SST</td><td>= Stainless steel</td></tr> <tr><td>SR</td><td>= split ring</td></tr> <tr><td>STL</td><td>= steel</td></tr> <tr><td>TA</td><td>= tantalum</td></tr> <tr><td>TD</td><td>= time delay</td></tr> <tr><td>TGL</td><td>= toggle</td></tr> <tr><td>THD</td><td>= thread</td></tr> <tr><td>TI</td><td>= titanium</td></tr> <tr><td>TOL</td><td>= tolerance</td></tr> <tr><td>TRIM</td><td>= trimmer</td></tr> <tr><td>TWT</td><td>= traveling wave tube</td></tr> <tr><td>μ</td><td>= micro = 10⁻⁶</td></tr> <tr><td>VAR</td><td>= variable</td></tr> <tr><td>VDCW</td><td>= dc working volts</td></tr> <tr><td>W/</td><td>= with</td></tr> <tr><td>W</td><td>= watts</td></tr> <tr><td>WIV</td><td>= working inverse voltage</td></tr> <tr><td>WW</td><td>= wirewound</td></tr> <tr><td>W/O</td><td>= without</td></tr> </table>	RMO	= rack mount only	RMS	= root-mean square	RWV	= reverse working voltage	S-B	= slow-blow	SCR	= screw	SE	= selenium	SECT	= section(s)	SEMICON	= semiconductor	SI	= silicon	SIL	= silver	SL	= slide	SPG	= spring	SPL	= special	SST	= Stainless steel	SR	= split ring	STL	= steel	TA	= tantalum	TD	= time delay	TGL	= toggle	THD	= thread	TI	= titanium	TOL	= tolerance	TRIM	= trimmer	TWT	= traveling wave tube	μ	= micro = 10 ⁻⁶	VAR	= variable	VDCW	= dc working volts	W/	= with	W	= watts	WIV	= working inverse voltage	WW	= wirewound	W/O	= without
A	= amperes																																																																																																																																																																																																																																																												
AFC	= automatic frequency control																																																																																																																																																																																																																																																												
AMPL	= amplifier																																																																																																																																																																																																																																																												
BFO	= beat frequency oscillator																																																																																																																																																																																																																																																												
BE CU	= beryllium copper																																																																																																																																																																																																																																																												
BH	= binder head																																																																																																																																																																																																																																																												
BP	= bandpass																																																																																																																																																																																																																																																												
BRS	= brass																																																																																																																																																																																																																																																												
BWO	= backward wave oscillator																																																																																																																																																																																																																																																												
CCW	= counterclockwise																																																																																																																																																																																																																																																												
CER	= ceramic																																																																																																																																																																																																																																																												
CMO	= cabinet mount only																																																																																																																																																																																																																																																												
COEF	= coefficient																																																																																																																																																																																																																																																												
COM	= common																																																																																																																																																																																																																																																												
COMP	= composition																																																																																																																																																																																																																																																												
COMPL	= complete																																																																																																																																																																																																																																																												
CONN	= connector																																																																																																																																																																																																																																																												
CP	= cadmium plate																																																																																																																																																																																																																																																												
CRT	= cathode-ray tube																																																																																																																																																																																																																																																												
CW	= clockwise																																																																																																																																																																																																																																																												
DEPC	= deposited carbon																																																																																																																																																																																																																																																												
DR	= drive																																																																																																																																																																																																																																																												
ELECT	= electrolytic																																																																																																																																																																																																																																																												
ENCAP	= encapsulated																																																																																																																																																																																																																																																												
EXT	= external																																																																																																																																																																																																																																																												
F	= farads																																																																																																																																																																																																																																																												
FH	= flat head																																																																																																																																																																																																																																																												
FIL H	= Fillister head																																																																																																																																																																																																																																																												
FXD	= fixed																																																																																																																																																																																																																																																												
G	= giga (10 ⁹)																																																																																																																																																																																																																																																												
GE	= germanium																																																																																																																																																																																																																																																												
GL	= glass																																																																																																																																																																																																																																																												
GRD	= ground(ed)																																																																																																																																																																																																																																																												
H	= henries																																																																																																																																																																																																																																																												
HDW	= hardware																																																																																																																																																																																																																																																												
HEX	= hexagonal																																																																																																																																																																																																																																																												
HG	= mercury																																																																																																																																																																																																																																																												
HR	= hour(s)																																																																																																																																																																																																																																																												
Hz	= Hertz																																																																																																																																																																																																																																																												
IF	= intermediate freq																																																																																																																																																																																																																																																												
IMPG	= impregnated																																																																																																																																																																																																																																																												
INCD	= incandescent																																																																																																																																																																																																																																																												
INCL	= include(s)																																																																																																																																																																																																																																																												
INS	= insulation(ed)																																																																																																																																																																																																																																																												
INT	= internal																																																																																																																																																																																																																																																												
K	= kilo = 1000																																																																																																																																																																																																																																																												
LH	= left hand																																																																																																																																																																																																																																																												
LIN	= linear taper																																																																																																																																																																																																																																																												
LK WASH	= lock washer																																																																																																																																																																																																																																																												
LOG	= logarithmic taper																																																																																																																																																																																																																																																												
LPF	= low pass filter																																																																																																																																																																																																																																																												
M	= milli = 10 ⁻³																																																																																																																																																																																																																																																												
MEG	= meg = 10 ⁶																																																																																																																																																																																																																																																												
MET FLM	= metal film																																																																																																																																																																																																																																																												
MET OX	= metallic oxide																																																																																																																																																																																																																																																												
MFR	= manufacturer																																																																																																																																																																																																																																																												
MHz	= mega Hertz																																																																																																																																																																																																																																																												
MINAT	= miniature																																																																																																																																																																																																																																																												
MOM	= momentary																																																																																																																																																																																																																																																												
MOS	= metalized substrate																																																																																																																																																																																																																																																												
MTG	= mounting																																																																																																																																																																																																																																																												
MY	= "mylar"																																																																																																																																																																																																																																																												
N	= nano (10 ⁻⁹)																																																																																																																																																																																																																																																												
N/C	= normally closed																																																																																																																																																																																																																																																												
NE	= neon																																																																																																																																																																																																																																																												
NI PL	= nickel plate																																																																																																																																																																																																																																																												
N/O	= normally open																																																																																																																																																																																																																																																												
NOM	= nominal																																																																																																																																																																																																																																																												
NPO	= negative positive zero (zero temperature coef-ficient)																																																																																																																																																																																																																																																												
NPN	= negative-positive-negative																																																																																																																																																																																																																																																												
NRFR	= not recommended for field re-placement																																																																																																																																																																																																																																																												
NSR	= not separately replaceable																																																																																																																																																																																																																																																												
OBD	= order by description																																																																																																																																																																																																																																																												
OH	= oval head																																																																																																																																																																																																																																																												
OX	= oxide																																																																																																																																																																																																																																																												
P	= peak																																																																																																																																																																																																																																																												
PC	= printed circuit																																																																																																																																																																																																																																																												
PF	= picofarads = 10 ⁻¹² farads																																																																																																																																																																																																																																																												
PH BRZ	= phosphor bronze																																																																																																																																																																																																																																																												
PHL	= Phillips																																																																																																																																																																																																																																																												
PIV	= peak inverse voltage																																																																																																																																																																																																																																																												
PNP	= positive-negative-positive																																																																																																																																																																																																																																																												
P/O	= part of																																																																																																																																																																																																																																																												
POLY	= polystyrene																																																																																																																																																																																																																																																												
PORC	= porcelain																																																																																																																																																																																																																																																												
POS	= position(s)																																																																																																																																																																																																																																																												
POT	= potentiometer																																																																																																																																																																																																																																																												
PP	= peak-to-peak																																																																																																																																																																																																																																																												
PT	= point																																																																																																																																																																																																																																																												
PWV	= peak working volt-age																																																																																																																																																																																																																																																												
RECT	= rectifier																																																																																																																																																																																																																																																												
RF	= radio frequency																																																																																																																																																																																																																																																												
RH	= round head or right hand																																																																																																																																																																																																																																																												
RMO	= rack mount only																																																																																																																																																																																																																																																												
RMS	= root-mean square																																																																																																																																																																																																																																																												
RWV	= reverse working voltage																																																																																																																																																																																																																																																												
S-B	= slow-blow																																																																																																																																																																																																																																																												
SCR	= screw																																																																																																																																																																																																																																																												
SE	= selenium																																																																																																																																																																																																																																																												
SECT	= section(s)																																																																																																																																																																																																																																																												
SEMICON	= semiconductor																																																																																																																																																																																																																																																												
SI	= silicon																																																																																																																																																																																																																																																												
SIL	= silver																																																																																																																																																																																																																																																												
SL	= slide																																																																																																																																																																																																																																																												
SPG	= spring																																																																																																																																																																																																																																																												
SPL	= special																																																																																																																																																																																																																																																												
SST	= Stainless steel																																																																																																																																																																																																																																																												
SR	= split ring																																																																																																																																																																																																																																																												
STL	= steel																																																																																																																																																																																																																																																												
TA	= tantalum																																																																																																																																																																																																																																																												
TD	= time delay																																																																																																																																																																																																																																																												
TGL	= toggle																																																																																																																																																																																																																																																												
THD	= thread																																																																																																																																																																																																																																																												
TI	= titanium																																																																																																																																																																																																																																																												
TOL	= tolerance																																																																																																																																																																																																																																																												
TRIM	= trimmer																																																																																																																																																																																																																																																												
TWT	= traveling wave tube																																																																																																																																																																																																																																																												
μ	= micro = 10 ⁻⁶																																																																																																																																																																																																																																																												
VAR	= variable																																																																																																																																																																																																																																																												
VDCW	= dc working volts																																																																																																																																																																																																																																																												
W/	= with																																																																																																																																																																																																																																																												
W	= watts																																																																																																																																																																																																																																																												
WIV	= working inverse voltage																																																																																																																																																																																																																																																												
WW	= wirewound																																																																																																																																																																																																																																																												
W/O	= without																																																																																																																																																																																																																																																												

Table 6-2. Replaceable Parts

Reference Designation	HP Part Number	Qty	Description	Mfr Code	Mfr Part Number
A1	08445-60001	1	BOARD ASSY:PRE-DRIVER	28480	08445-60001
A1C1	0160-2055	15	C:FXD CER 0.01 UF +80-20% 100VDCW	56289	C023F101F103ZS22-CDH
A1C2	0160-2055		C:FXD CER 0.01 UF +80-20% 100VDCW	56289	C023F101F103ZS22-CDH
A1CR1	1902-0025	7	DIODE,BREAKDOWN:10.0V 5% 400 MW	28480	1902-0025
A1CR2	1901-0025	16	DIODE:SILICON 100MA/1V	07263	FD 2387
A1CR3	1901-0025		DIODE:SILICON 100MA/1V	07263	FD 2387
A1CR4	1901-0025		DIODE:SILICON 100MA/1V	07263	FD 2387
A1CR5	1902-0025		DIODE,BREAKDOWN:10.0V 5% 400 MW	28480	1902-0025
A1CR6	1901-0025		DIODE:SILICON 100MA/1V	07263	FD 2387
A1CR7	1901-0025		DIODE:SILICON 100MA/1V	07263	FD 2387
A1CR8	1902-0041	4	DIODE:BREAKDOWN 5.11V 5%	04713	S210939-98
A1CR9	1902-0041		DIODE:BREAKDOWN 5.11V 5%	04713	S210939-98
A1CR10	1902-0025		DIODE,BREAKDOWN:10.0V 5% 400 MW	28480	1902-0025
A1CR11	1901-0025		DIODE:SILICON 100MA/1V	07263	FD 2387
A1CR12	1901-0025		DIODE:SILICON 100MA/1V	07263	FD 2387
A1CR13	1901-0025		DIODE:SILICON 100MA/1V	07263	FD 2387
A1CR14	1901-0025		DIODE:SILICON 100MA/1V	07263	FD 2387
A1CR15	1901-0025		DIODE:SILICON 100MA/1V	07263	FD 2387
A1CR16	1902-0025		DIODE,BREAKDOWN:10.0V 5% 400 MW	28480	1902-0025
A1CR17	1902-0041		DIODE:BREAKDOWN 5.11V 5%	04713	S210939-98
A1K1	0490-0367	3	RELAY:REED 2.75K OHM	28480	0490-0367
A1K2	0490-0367		RELAY:REED 2.75K OHM	28480	0490-0367
A1K3	0490-0367		RELAY:REED 2.75K OHM	28480	0490-0367
A1K4	0490-0760	2	RELAY:REED 0.1AMP MAX. 250V MIN.	28480	0490-0760
A1K5	0490-0760		RELAY:REED 0.1AMP MAX. 250V MIN.	28480	0490-0760
A1Q1	1854-0071	8	TSTR:SI NPN(SELECTED FROM 2N3704)	28480	1854-0071
A1Q2	1854-0071		TSTR:SI NPN(SELECTED FROM 2N3704)	28480	1854-0071
A1Q3	1854-0071		TSTR:SI NPN(SELECTED FROM 2N3704)	28480	1854-0071
A1Q4	1854-0071		TSTR:SI NPN(SELECTED FROM 2N3704)	28480	1854-0071
A1Q5	1854-0071		TSTR:SI NPN(SELECTED FROM 2N3704)	28480	1854-0071
A1Q6	1854-0071		TSTR:SI NPN(SELECTED FROM 2N3704)	28480	1854-0071
A1Q7	1854-0071		TSTR:SI NPN(SELECTED FROM 2N3704)	28480	1854-0071
A1Q8	1854-0071		TSTR:SI NPN(SELECTED FROM 2N3704)	28480	1854-0071
A1Q9	1853-0020	4	TSTR:SI PNP(SELECTED FROM 2N3702)	28480	1853-0020
A1Q10	1853-0020		TSTR:SI PNP(SELECTED FROM 2N3702)	28480	1853-0020
A1R1	0757-0401	5	R:FXD MET FLM 100 OHM 1% 1/8W	28480	0757-0401
A1R2	0811-3007	7	R:FXD WW 10K OHM 0.01% 1/32W	28480	0811-3007
A1R3	0811-3007		R:FXD WW 10K OHM 0.01% 1/32W	28480	0811-3007
A1R4	0811-3008	4	R:FXD WW 8K OHM 0.01% 1/32W	28480	0811-3008
A1R5	0811-3008		R:FXD WW 8K OHM 0.01% 1/32W	28480	0811-3008
A1R6	0811-3008		R:FXD WW 8K OHM 0.01% 1/32W	28480	0811-3008
A1R7	0811-3008		R:FXD WW 8K OHM 0.01% 1/32W	28480	0811-3008
A1R8	2100-1776	6	R:VAR WW 10K OHM 5% TYPE H 1W	28480	2100-1776
A1R9	0698-3157	5	R:FXD MET FLM 19.6K OHM 1% 1/8W	28480	0698-3157
A1R10	0757-0441	2	R:FXD MET FLM 8.25K OHM 1% 1/8W	28480	0757-0441
A1R11	0757-0440	1	R:FXD MET FLM 7.50K OHM 1% 1/8W	28480	0757-0440
A1R12	0757-0447	1	R:FXD MET FLM 16.2K OHM 1% 1/8W	28480	0757-0447
A1R13	0757-0401		R:FXD MET FLM 100 OHM 1% 1/8W	28480	0757-0401
A1R14	0811-3007		R:FXD WW 10K OHM 0.01% 1/32W	28480	0811-3007
A1R15	THRU		NOT ASSIGNED		
A1R18			NOT ASSIGNED		
A1R19	0811-3007		R:FXD WW 10K OHM 0.01% 1/32W	28480	0811-3007
A1R20	0811-3007		R:FXD WW 10K OHM 0.01% 1/32W	28480	0811-3007
A1R21	0757-0438	2	R:FXD MET FLM 5.11K OHM 1% 1/8W	28480	0757-0438
A1R22	0757-0442	6	R:FXD MET FLM 10.0K OHM 1% 1/8W	28480	0757-0442
A1R23	2100-1776		R:VAR WW 10K OHM 5% TYPE H 1W	28480	2100-1776
A1R24	0757-0401		R:FXD MET FLM 100 OHM 1% 1/8W	28480	0757-0401
A1R25	0811-3009	1	R:FXD WW 44.0K OHM 1.0% 1/8W	28480	0811-3009
A1R26	2100-1774	2	R:VAR WW 2K OHM 5% TYPE H 1W	28480	2100-1774
A1R27	0811-3112	1	R:FXD WW 117.5K OHM 1% 1W	28480	0811-3112
A1R28	2100-1776		R:VAR WW 10K OHM 5% TYPE H 1W	28480	2100-1776
A1R29	0811-3007		R:FXD WW 10K OHM 0.01% 1/32W	28480	0811-3007
A1R30	0757-0401		R:FXD MET FLM 100 OHM 1% 1/8W	28480	0757-0401
A1R31	2100-1776		R:VAR WW 10K OHM 5% TYPE H 1W	28480	2100-1776
A1R32	0757-0441		R:FXD MET FLM 8.25K OHM 1% 1/8W	28480	0757-0441
A1R33	0757-0274	1	R:FXD MET FLM 1.21K OHM 1% 1/8W	28480	0757-0274
A1R34	0757-0458	10	R:FXD MET FLM 51.1K OHM 1% 1/8W	28480	0757-0458
A1R35	0698-3157		R:FXD MET FLM 19.6K OHM 1% 1/8W	28480	0698-3157
A1R36	0757-0458		R:FXD MET FLM 51.1K OHM 1% 1/8W	28480	0757-0458
A1R37	0698-3157		R:FXD MET FLM 19.6K OHM 1% 1/8W	28480	0698-3157
A1R38	0757-0458		R:FXD MET FLM 51.1K OHM 1% 1/8W	28480	0757-0458
A1R39	0698-3157		R:FXD MET FLM 19.6K OHM 1% 1/8W	28480	0698-3157
A1R40	0757-0458		R:FXD MET FLM 51.1K OHM 1% 1/8W	28480	0757-0458
A1R41	0698-3157		R:FXD MET FLM 19.6K OHM 1% 1/8W	28480	0698-3157
A1R42			NOT ASSIGNED		

See introduction to this section for ordering information

Table 6-2. Replaceable Parts

Reference Designation	HP Part Number	Qty	Description	Mfr Code	Mfr Part Number
A1R43	0757-0465	6	R:FXD MET FLM 100K OHM 1% 1/8W	28480	0757-0465
A1R44	0757-0280	4	R:FXD MET FLM 1K OHM 1% 1/8W	28480	0757-0280
A1R45	0757-0280		R:FXD MET FLM 1K OHM 1% 1/8W	28480	0757-0280
A1R46	0757-0465		R:FXD MET FLM 100K OHM 1% 1/8W	28480	0757-0465
A1R47	0757-0465		R:FXD MET FLM 100K OHM 1% 1/8W	28480	0757-0465
A1R48	0683-1055	1	R:FXD COMP 1 MEGOHM 5% 1/4W	01121	CB 1055
A1R49	0757-0442		R:FXD MET FLM 10.0K OHM 1% 1/8W	28480	0757-0442
A1R50	0757-0465		R:FXD MET FLM 100K OHM 1% 1/8W	28480	0757-0465
A1R51	0757-0438		R:FXD MET FLM 5.11K OHM 1% 1/8W	28480	0757-0438
A1R52	0757-0458		R:FXD MET FLM 51.1K OHM 1% 1/8W	28480	0757-0458
A1R53	0757-0199	2	R:FXD MET FLM 21.5K OHM 1% 1/8W	28480	0757-0199
A1R54	0757-0465		R:FXD MET FLM 100K OHM 1% 1/8W	28480	0757-0465
A1R55	0757-0443	1	R:FXD MET FLM 11.0K OHM 1% 1/8W	28480	0757-0443
A1S1	3101-1162	2	SWITCH:SLIDE MINIATURE, SPDT	79727	GF124-0008
A1T01	08445-20001	1	BOARD:BLANK PC	28480	08445-20001
A1TP1	0360-1514	16	TERMINAL PIN:SQUARE	28480	0360-1514
A1TP2	0360-1514		TERMINAL PIN:SQUARE	28480	0360-1514
A1TP3	0360-1514		TERMINAL PIN:SQUARE	28480	0360-1514
A1TP4	0360-1514		TERMINAL PIN:SQUARE	28480	0360-1514
A1TP5	0360-1514		TERMINAL PIN:SQUARE	28480	0360-1514
A1J1	1826-0013	8	IC:LINEAR	28480	1826-0013
A1J2	1826-0013		IC:LINEAR	28480	1826-0013
A1J3	1826-0013		IC:LINEAR	28480	1826-0013
A1J4	1826-0013		IC:LINEAR	28480	1826-0013
A1J5	1826-0013		IC:LINEAR	28480	1826-0013
A2	08445-60003	1	BOARD ASSY:POWER SUPPLY	28480	08445-60003
A2C1	0180-2181	1	C:FXD ELECT 1300 UF +75-10% 50VDCW	56289	36D132G050AA2A-DQB
A2C2	0180-1819	1	C:FXD ELECT 100 UF +75-10% 50VDCW	28480	0180-1819
A2C3	0160-3467	1	C:FXD CER DISC 100 PF 10% 250VDCW	56289	C157B251F101KS25-CDH
A2C4	0160-3459	1	C:FXD CER 0.02 UF 20% 100VDCW	56289	C023F101H203MS22CDH
A2C5	0160-2055		C:FXD CER 0.01 UF +80-20% 100VDCW	56289	C023F101F103ZS22-CDH
A2CR1	1901-0200	4	DIODE:SILICON 100 PIV 3A	02735	1N4998
A2CR2	1901-0200		DIODE:SILICON 100 PIV 3A	02735	1N4998
A2CR3	1901-0200		DIODE:SILICON 100 PIV 3A	02735	1N4998
A2CR4	1901-0200		DIODE:SILICON 100 PIV 3A	02735	1N4998
A2CR5	1901-0159	4	DIODE:SILICON 0.75A 400PIV	04713	SR1358-4
A2CR6	1901-0159		DIODE:SILICON 0.75A 400PIV	04713	SR1358-4
A2CR7	1901-0159		DIODE:SILICON 0.75A 400PIV	04713	SR1358-4
A2CR8	1901-0159		DIODE:SILICON 0.75A 400PIV	04713	SR1358-4
A2CR9	1902-3256	1	DIODE:BREAKDOWN SILICON 23.7V 5%	28480	1902-3256
A2CR10	1901-0025		DIODE:SILICON 100MA/1V	07263	FD 2387
A2CR11	1901-0025		DIODE:SILICON 100MA/1V	07263	FD 2387
A2CR12	1901-0025		DIODE:SILICON 100MA/1V	07263	FD 2387
A2CR13	1901-0025		DIODE:SILICON 100MA/1V	07263	FD 2387
A2CR14	1902-0025		DIODE,BREAKDOWN:10.0V 5% 400 MW	28480	1902-0025
A2CR15	1902-0025		DIODE,BREAKDOWN:10.0V 5% 400 MW	28480	1902-0025
A2CR16	1902-3245	2	DIODE BREAKDOWN:SILICON 21.5V 5%	28480	1902-3245
A2CR17	1902-3245		DIODE BREAKDOWN:SILICON 21.5V 5%	28480	1902-3245
A2CR18	1902-0041		DIODE:BREAKDOWN 5.11V 5%	04713	SZ10939-98
A2CR19	1902-3268	2	DIODE BREAKDOWN:26.1V 5%	28480	1902-3268
A2CR20	1902-3268		DIODE BREAKDOWN:26.1V 5%	28480	1902-3268
A2CR21	1902-3279	1	DIODE BREAKDOWN:28.7V	28480	1902-3279
A2F1	2110-0012	2	FUSE:0.5 AMP 250V	75915	312-500
A2F2	2110-0027	1	FUSE:0.125A 250V	75915	312-125
A2MP1	1205-0011	1	HEAT DISSIPATOR:FOR T0-5 AND T0-9 CASES	98978	TXBF-032-0258
A2MP1	0340-0162	2	INSULATOR:TSTR FOR T0-66	13103	A0340-0162-1
A2MP2	2110-0269	4	CLIP:FUSE 0.250" DIA	91506	6008-32CN
A2Q1	1854-0072	1	TSTR:SI NPN	80131	2N3054
A2Q2	1854-0022	4	TSTR:SI NPN	07263	S17843
A2Q3	1853-0012	4	TSTR:SI PNP	80131	2N2904A
A2Q4	1853-0012		TSTR:SI PNP	80131	2N2904A
A2Q5	1854-0022		TSTR:SI NPN	07263	S17843
A2Q6	1854-0022		TSTR:SI NPN	07263	S17843
A2Q7	1853-0012		TSTR:SI PNP	80131	2N2904A
A2Q8	1853-0012		TSTR:SI PNP	80131	2N2904A
A2Q9	1854-0039	1	TSTR:SI NPN	80131	2N3053
A2Q10	1853-0020		TSTR:SI PNP(SELECTED FROM 2N3702)	28480	1853-0020
A2R1	0757-0279	2	R:FXD MET FLM 3.16K OHM 1% 1/8W	28480	0757-0279
A2R2	0757-0439	1	R:FXD MET FLM 6.81K OHM 1% 1/8W	28480	0757-0439
A2R3	0683-0275	1	R:FXD COMP 2.7 OHM 5% 1/4W	01121	CB 27G5
A2R4	0698-3136	3	R:FXD MET FLM 17.8K OHM 1% 1/8W	28480	0698-3136
A2R5	2100-1774		R:VAR WW 2K OHM 5% TYPE H 1W	28480	2100-1774
A2R6	0757-0442		R:FXD MET FLM 10.0K OHM 1% 1/8W	28480	0757-0442
A2R7	0757-0458		R:FXD MET FLM 51.1K OHM 1% 1/8W	28480	0757-0458
A2R8	0698-3136		R:FXD MET FLM 17.8K OHM 1% 1/8W	28480	0698-3136

See introduction to this section for ordering information

Table 6-2. Replaceable Parts

Reference Designation	HP Part Number	Qty	Description	Mfr Code	Mfr Part Number
A2R9	0698-3637	1	R:FXD MET OX 820 OHM 5% 2W	28480	0698-3637
A2R10	0698-3620	1	R:FXD MET OX 100 OHM 5% 2W	28480	0698-3620
A2R11	0698-3156	1	R:FXD MET FLM 14.7K OHM 1% 1/8W	28480	0698-3156
A2R12	0764-0016	1	R:FXD MET FLM 1000 OHM 5% 2W	28480	0764-0016
A2R13	0698-0083	1	R:FXD MET FLM 1.96K OHM 1% 1/8W	28480	0698-0083
A2R14	0757-0466	1	R:FXD MET FLM 110K OHM 1% 1/8W	28480	0757-0466
A2R15	0757-0465	1	R:FXD MET FLM 100K OHM 1% 1/8W	28480	0757-0465
A2R16	0698-3260	4	R:FXD MET FLM 464K OHM 1% 1/8W	28480	0698-3260
A2R17	0698-3260	1	R:FXD MET FLM 464K OHM 1% 1/8W	28480	0698-3260
A2R18	0698-3260	1	R:FXD MET FLM 464K OHM 1% 1/8W	28480	0698-3260
A2R19	0698-3260	1	R:FXD MET FLM 464K OHM 1% 1/8W	28480	0698-3260
A2R20	2100-1767	2	R:VAR WW 10 OHM 5% TYPE H 1W	28480	2100-1767
A2R21	2100-1767	1	R:VAR WW 10 OHM 5% TYPE H 1W	28480	2100-1767
A2R22	1810-0037	1	RESISTOR ARRAY:1K OHM 2% 1W EACH	28480	1810-0037
A2R23	2100-1776	1	R:VAR WW 10K OHM 5% TYPE H 1W	28480	2100-1776
A2R24	0698-3241	1	R:FXD FLM 250 OHM 0.25% 1/8W	28480	0698-3241
A2R25	0757-0442	1	R:FXD MET FLM 10.0K OHM 1% 1/8W	28480	0757-0442
A2R26	0757-0442	1	R:FXD MET FLM 10.0K OHM 1% 1/8W	28480	0757-0442
A2T81	08445-20003	1	BOARD:BLANK PC	28480	08445-20003
A2TP1	0360-1514	1	TERMINAL PIN:SQUARE	28480	0360-1514
A2TP2	0360-1514	1	TERMINAL PIN:SQUARE	28480	0360-1514
A2TP3	0360-1514	1	TERMINAL PIN:SQUARE	28480	0360-1514
A2TP4	0360-1514	1	TERMINAL PIN:SQUARE	28480	0360-1514
A2TP5	0360-1514	1	TERMINAL PIN:SQUARE	28480	0360-1514
A2TP6	0360-1514	1	TERMINAL PIN:SQUARE	28480	0360-1514
A2TP7	0360-1514	1	TERMINAL PIN:SQUARE	28480	0360-1514
A2U1	1820-0196	1	IC:LINEAR VOLTAGE REGULATOR(INPUT)	28480	1820-0196
A2U2	1826-0013	1	IC:LINEAR	28480	1826-0013
A2U3	1826-0013	1	IC:LINEAR	28480	1826-0013
A3	08445-60002	1	BOARD ASSY:DRIVER	28480	08445-60002
A3C1	0160-3094	1	C:FXD CER 1 UF 10% 100VDCW	28480	0160-3094
A3C2	0160-2055	1	C:FXD CER 0.01 UF +80-20% 100VDCW	56289	C023F101F103ZS22-CDH
A3C3	0160-3455	1	C:FXD CER 470 PF 10% 1000VDCW	56289	C067F102F471KS22
A3CR1	1901-0025	1	DIODE:SILICON 100MA/1V	07263	FD 2387
A3CR2	1902-3182	1	DIODE BREAKDOWN:SILICON 12.1V 5%	28480	1902-3182
A3CR3	1901-0025	1	DIODE:SILICON 100MA/1V	07263	FD 2387
A3CR4	1902-0175	1	DIODE BREAKDOWN:100V	28480	1902-0175
A3CR5	1902-0685	1	DIODE BREAKDOWN:9.0V 2% T.C.=.001%/C° MAX.	04713	1N938
A3CR6	1902-3104	1	DIODE:BREAKDOWN 5.62V 5%	04713	S210939-110
A3CR7	1902-0184	1	DIODE BREAKDOWN:SILICON 16.2V 5%	28480	1902-0184
A3CR8	1902-3203	1	DIODE BREAKDOWN:SILICON 14.7V 5%	28480	1902-3203
A3CR9	1902-0025	1	DIODE, BREAKDOWN:10.0V 5% 400 MW	28480	1902-0025
A3F1	2110-0094	1	FUSE:1.25A 250V	75915	3121.25
A3J1	1251-2313	2	CONNECTOR:SINGLE CONTACT	00779	3-332070-5
A3J2	1251-2313	2	CONNECTOR:SINGLE CONTACT	00779	3-332070-5
A3K1	0490-0894	1	RELAY:2 FORM C 2 AMP 30VDC	77342	HP11D
A3MP1	1200-0043	1	INSULATOR:TSTR MOUNTING(TO-3)	71785	293011
A3MP2	1200-0081	2	INSULATOR:BUSHING, NYLON	26365	974 307
A3MP3	0340-0162	1	INSULATOR:TSTR FOR TO-66	13103	A0340-0162-1
A3MP4	2110-0269	1	CLIP:FUSE 0.250" DIA	91506	6008-32CN
A3MP5	08445-00003	1	HEAT SINK:DRIVER	28480	08445-00003
A3Q1	1854-0022	1	TSTR:SI NPN	07263	S17843
A3Q2	1853-0020	1	TSTR:SI PNP(SELECTED FROM 2N3702)	28480	1853-0020
A3Q3	1854-0237	1	TSTR:SI NPN	80131	2N3738
A3Q4	1854-0217	1	TSTR:SI NPN	80131	2N3442
A3R1	0757-0458	1	R:FXD MET FLM 51.1K OHM 1% 1/8W	28480	0757-0458
A3R2	0757-0422	1	R:FXD MET FLM 909 OHM 1% 1/8W	28480	0757-0422
A3R3	0811-3007	1	R:FXD WW 10K OHM 0.01% 1/32W	28480	0811-3007
A3R4	0698-3161	1	R:FXD MET FLM 38.3K OHM 1% 1/8W	28480	0698-3161
A3R5	0698-3434	1	R:FXD MET FLM 34.8 OHM 1% 1/8W	28480	0698-3434
A3R5	0811-1362	1	FACTORY SELECTED PART	28480	0811-1362
A3R6	2100-1776	1	R:FXD WW 1000 OHM 0.01% 1/4W	28480	2100-1776
A3R7	0811-3040	1	R:VAR WW 10K OHM 5% TYPE H 1W	28480	0811-3040
A3R8	0757-0442	1	R:FXD WW 2.601 OHM 0.1% 2-1/2W	28480	0757-0442
A3R9	0757-0442	1	R:FXD MET FLM 10.0K OHM 1% 1/8W	28480	0757-0442
A3R10	0757-0317	1	R:FXD MET FLM 1.33K OHM 1% 1/8W	28480	0757-0317
A3R11	0698-3150	1	R:FXD MET FLM 2.37K OHM 1% 1/8W	28480	0698-3150
A3R12	0698-3441	1	R:FXD MET FLM 215 OHM 1% 1/8W	28480	0698-3441
A3R13	0757-0199	1	R:FXD MET FLM 21.5K OHM 1% 1/8W	28480	0757-0199
A3R14	0757-0280	1	R:FXD MET FLM 1K OHM 1% 1/8W	28480	0757-0280
A3R15	0757-0279	1	R:FXD MET FLM 3.16K OHM 1% 1/8W	28480	0757-0279
A3R16	0698-3136	1	R:FXD MET FLM 17.8K OHM 1% 1/8W	28480	0698-3136
A3R17	0757-0280	1	R:FXD MET FLM 1K OHM 1% 1/8W	28480	0757-0280
A3R18	0698-3160	1	R:FXD MET FLM 31.6K OHM 1% 1/8W	28480	0698-3160
A3R19			NOT ASSIGNED		

See introduction to this section for ordering information

Table 6-2. Replaceable Parts

Reference Designation	HP Part Number	Qty	Description	Mfr Code	Mfr Part Number
A3R20			NOT ASSIGNED		
A3R21	2100-1777	3	R:VAR WW 20K OHM 5% TYPE H 1W	28480	2100-1777
A3R22	0757-0458		R:FXD MET FLM 51.1K OHM 1% 1/8W	28480	0757-0458
A3R23	0757-0460	3	R:FXD MET FLM 61.9K OHM 1% 1/8W	28480	0757-0460
A3R24	2100-1777		R:VAR WW 20K OHM 5% TYPE H 1W	28480	2100-1777
A3R25	0757-0458		R:FXD MET FLM 51.1K OHM 1% 1/8W	28480	0757-0458
A3R26	0757-0460		R:FXD MET FLM 61.9K OHM 1% 1/8W	28480	0757-0460
A3R27	0757-0460		R:FXD MET FLM 61.9K OHM 1% 1/8W	28480	0757-0460
A3R28	0757-0458		R:FXD MET FLM 51.1K OHM 1% 1/8W	28480	0757-0458
A3R29	2100-1777		R:VAR WW 20K OHM 5% TYPE H 1W	28480	2100-1777
A3R30	0757-0401		R:FXD MET FLM 100 OHM 1% 1/8W	28480	0757-0401
A3S1	3101-1162		SWITCH:SLIDE MINIATURE, SPDT	79727	GF124-0008
A3T81	08445-20002	1	BOARD:BLANK PC	28480	08445-20002
A3TP1	0360-1514		TERMINAL PIN:SQUARE	28480	0360-1514
A3TP2	0360-1514		TERMINAL PIN:SQUARE	28480	0360-1514
A3TP3	0360-1514		TERMINAL PIN:SQUARE	28480	0360-1514
A3TP4	0360-1514		TERMINAL PIN:SQUARE	28480	0360-1514
A3U1	1826-0013		IC:LINEAR	28480	1826-0013
A4			YIG FILTER ASSY:NOT RECOMMENDED FOR FIELD REPAIR. SELECT FROM REBUILT OR		
A4			REPLACEMENT ASSY'S LISTED BELOW.		
A4	08445-60014	1	YIG FILTER REPLACEMENT ASSY	28480	08445-60014
A4			STD AND OPT 020 INSTRUMENTS		
A4			INCLUDES CALIBRATION LABEL.		
A4	08445-60015	1	REBUILT 08445-60014 YIG FILTER ASSY	28480	08445-60015
A4			INCLUDES CALIBRATION LABEL.		
A4	08445-60016	1	YIG FILTER REPLACEMENT ASSY	28480	08445-60016
A4			OPTIONS 010 AND 030 INCLUDES CALIBRATION LABEL.		
A4	08445-60017	1	REBUILT 08445-60016 YIG FILTER ASSY	28480	08445-60017
A4			INCLUDES CALIBRATION LABEL.		
A5	08445-60009	1	BOARD ASSY:INTERCONNECT	28480	08445-60009
A5R1	0698-3453	1	R:FXD MET FLM 196K OHM 1% 1/8W	28480	0698-3453
A5T81	08445-20009	1	BOARD:BLANK PC	28480	08445-20009
A5XA1	1251-1886	3	CONN:PC 30-CONTACT (2X15)	71785	252-15-30-340
A5XA2	1251-1886		CONN:PC 30-CONTACT (2X15)	71785	252-15-30-340
A5XA3	1251-1886		CONN:PC 30-CONTACT (2X15)	71785	252-15-30-340
A5Z	1251-1115	3	KEY:POLARIZING FOR CKT BD SOCKETS	71785	456-99-99-193
A6	5060-1189	1	POWER LINE MODULE, NON-FILTERED	28480	5060-1189
A6C1	0160-3043	1	C:FXD CER 2 X 0.005 UF 20% 250VAC	56289	29C147A-CDH
A6L1, L2	9140-0114	2	COIL:FXD RF 10 UH	28480	9140-0114
B1	3160-0209	1	FAN:AXIAL 115V 50/60HZ	23936	8500
C1	0160-3451	2	C:FXD CER 0.01 UF +80-20% 100VDCW	56289	C0238101F103ZS25-CDH
C2	0160-3451		C:FXD CER 0.01 UF +80-20% 100VDCW	56289	C0238101F103ZS25-CDH
F1	2110-0001	1	FUSE:1 AMP 250V	75915	312001.
F1			(FOR 115 VOLT OPERATION)		
F1	2110-0012		FUSE:0.5 AMP 250V	75915	312.500
F1			(FOR 230 VOLT OPERATION)		
FL1	0960-0159	1	FILTER:LOW PASS 0-1.8 GHZ	28480	0960-0159
FL1			DELETE FOR OPTIONS 010 AND 030		
J1, J2			CONNECTOR:FILTER PORT SEE SERVICE SHEET 5 AND TYPE N OR APC-7 BELOW		
J1, J2			CONNECTOR:FILTER PORT TYPE N		
J1, J2 MP1	1250-0914	2	BODY:RF CONNECTOR	02660	131-150
J1, J2 MP2	1250-0915	2	CONTACT:RF CONNECTOR	02660	131-149
J1, J2 MP3	5040-0306	2	INSULATOR	28480	5040-0306
J1, J2 MP4	08555-20093	2	CONTACT:JACK	28480	08555-20093
J1, J2 MP5	08555-20094	2	BODY:BULKHEAD	28480	08555-20094
J1, J2 MP6	2190-0104	2	WASHER:LOCK 0.439" ID	00000	08D
J1, J2 MP7	2950-0132	2	NUT:HEX 7/16-28	00000	08D
J1, J2 MP8	08761-2027	2	INSULATOR	28480	08761-2027
J1			CONNECTOR:FILTER PORT APC-7		
J1			OPTION 001 INSTRUMENTS		
J1MP1	1250-0909	2	BODY:FEMALE,RF CONNECTOR	02660	131-1057
J1MP2	1250-0816	2	PIN:FEMALE,RF CONNECTOR	02660	131-1054
J1MP3	5040-0306		INSULATOR	28480	5040-0306
J1MP4	08555-20093		CONTACT:JACK	28480	08555-20093
J1MP5	08555-20094		BODY:BULKHEAD	28480	08555-20094
J1MP6	2190-0104		WASHER:LOCK 0.439" ID	00000	08D
J1MP7	2950-0132		NUT:HEX 7/16-28	00000	08D
J1MP8	08761-2027		INSULATOR	28480	08761-2027
J2			CONNECTOR:FILTER PORT APC-7		
J2			OPTION 001 INSTRUMENTS		
J2MP1	1250-0909		BODY:FEMALE,RF CONNECTOR	02660	131-1057
J2MP2	1250-0816		PIN:FEMALE,RF CONNECTOR	02660	131-1054

See introduction to this section for ordering information

Table 6-2. Replaceable Parts

Reference Designation	HP Part Number	Qty	Description	Mfr Code	Mfr Part Number
J2 MP3	5040-0306		INSULATOR	28480	5040-0306
J2 MP4	08555-20093		CONTACT:JACK	28480	08555-20093
J2 MP5	08555-20094		BODY:BULKHEAD	28480	08555-20094
J2 MP6	2190-0104		WASHER:LOCK 0.439" ID	00000	080
J2 MP7	2950-0132		NUT:HEX 7/16-28	00000	080
J2 MP8	08761-2027		INSULATOR	28480	08761-2027
J3			SEE A6 POWER LINE MODULE		
J4	1250-0118	1	CONNECTOR:BNC	24931	28JR 128-1
J4			REMOTE INPUT CONNECTOR		
J4	5040-0702	2	INSULATOR:CONNECTOR	28480	5040-0702
J4	2190-0016	1	WASHER:LOCK PH BRZ NP	00000	080
J4	2950-0001	1	NUT:HEX BRZ NP 3/8-32 X 1/2	73734	9002
J4	0360-1190	1	LUG:SOLDER B.N.C.	79963	720 SPEC
J5	1251-2214	2	CONNECTOR:R & P 12 MALE CONTACTS	71785	DCM17W5P
J5	1251-0179	2	CONNECTOR:COAXIAL	71468	0M-53740-5001
J5	1251-0218	2	CONNECTOR:LOCK POST SUBMINAT TYPE D	71468	D53018
K1	08445-60011	2	SWITCH:PRECISION, COAXIAL	28480	08445-60011
K1			DELETE FOR OPTIONS 010 AND 030		
K2	08445-60011		SWITCH:PRECISION, COAXIAL	28480	08445-60011
K2			DELETE FOR OPTIONS 010 AND 030		
MP1	1490-0030	1	CABINET PARTS		
MP2	3150-0224	1	STAND:TILT	28480	1490-0030
MP3	5000-0050	2	FILTER:AIR	28480	3150-0224
MP4	5000-0731	2	TRIM:SIDES	28480	5000-0050
MP4			COVER:SIDE PERFORATED	28480	5000-0731
MP5	5020-0900	1	FRONT PANEL:TRIM, BOTTOM	28480	5020-0900
MP6	5020-0901	1	FRONT PANEL:TRIM, TOP	28480	5020-0901
MP7	5060-0730	2	FRAME ASSY:3 X 16	28480	5060-0730
MP8	5060-0767	5	FOOT ASSY:FM	28480	5060-0767
MP9	08443-40001	1	WINDOW:COUNTER	28480	08443-40001
MP10	08443-40002	1	WINDOW TRIM STRIP	28480	08443-40002
MP11	08445-00007	1	PLATE:CONNECTOR	28480	08445-00007
MP12	08445-00008	4	CLAMP:FRONT PANEL TRIM	28480	08445-00008
MP13	08445-00014	1	PANEL:FRONT	28480	08445-00014
MP13			FOR OPTION 020 AND 030		
MP14	08445-00015	1	SUB-PANEL:FRONT	28480	08445-00015
MP15	08445-00016	1	PANEL:REAR	28480	08445-00016
MP15	08445-00017	1	PANEL:FRONT (STANDARD)	28480	08445-00017
MP16			FOR OPTIONS 020 AND 030		
MP17	08445-00018	1	COVER:TOP	28480	08445-00018
MP18	08445-00019	1	COVER:BOTTOM	28480	08445-00019
MP19	08445-00020	1	DECK	28480	08445-00020
MP20	08445-00021	1	BAFFLE:AIR	28480	08445-00021
MP21	08445-00009	1	BRACKET MOUNTING (R1 AND R2)	28480	08445-00009
MP22	08445-00001	2	BRACKET MOUNTING, BOTTOM		
MP22			DELETE FOR OPTIONS 010 AND 030		
MP23	08445-00002	2	BRACKET MOUNTING, TOP	28480	08445-00002
MP23			DELETE FOR OPTIONS 010 AND 030		
MP23	5060-0216	1	BRACKET:JOINING KIT	28480	5060-0216
MP23	5060-0774	1	KIT:RACK MOUNT	28480	5060-0774
P1	1251-0958	1	CONNECTOR:R & P, 50 FEMALE CONTACT	71468	DD-505
P1	5940-0327	1	HOOD:CONNECTOR	28480	5040-0327
P1	2200-0109	1	SCREW:PAN HD POZ1 DR 4-40 X 0.438" LG	00000	080
R1	2100-3105	2	R:VAR COMP, 100 OHM 10% LIN 1/2W	28480	2100-3105
R1			(FREQ. OFFSET CONTROL)		
R1	08445-20004	1	KNOB:KNURLED	28480	08445-20004
R2	2100-3105		R:VAR COMP 100 OHM 10% LIN 1/2W	28480	2100-3105
R2			(TRACKING CONTROL)		
R3	0757-0459	1	R:FXD MET FLM 56.2K OHM 1% 1/8W	28480	0757-0459
R4	2100-3128	2	R:VAR WW 10K OHM 10% LIN 2W	28480	2100-3128
R4			(COARSE TUNE CONTROL, OPT. 020 & 030)		
R4	08445-00004	1	KNOB:DIAL COARSE TUNE	28480	08445-00004
R5	2100-3128		R:VAR WW 10K OHM 10% LIN 2W	28480	2100-3128
R5			(FINE TUNE CONTROL, OPT. 020 P 030)		
R5	08445-00005	1	KNOB:DIAL FINE TUNE	28480	08445-00005
S1	3101-1395	1	SWITCH:PUSHBUTTON DPDT-DB	76854	53-67280-121/A1H
S2	3100-3016	1	SWITCH:ROTARY	28480	3100-3016
S2			(MODE SWITCH, OPT. 020 & 030)		
S2	08445-00006	1	KNOB:DIAL MODE	28480	08445-00006
S2			(OPTION 030)		
S2	08445-00010	1	KNOB:DIAL MODE	28480	08445-00010
S2			(OPTION 020)		
T1	9100-3144	1	TRANSFORMER:POWER (50-60 HZ)	28480	9100-3144
T81	0360-1588	1	TERMINAL:STRIP 2-INSULATED 1-GROUND	71785	SPEC A1,G,A1
W1	08445-20022	1	CABLE ASSY:RF RIGID(STANDARD)	28480	08445-20022
W1			(SEE TABLE 1-5 FOR ALTERNATE)		

See introduction to this section for ordering information

Table 6-2. Replaceable Parts

Reference Designation	HP Part Number	Qty	Description	Mfr Code	Mfr Part Number
W2	8120-1348	1	CABLE ASSY:POWER, DETACHABLE (SEE FIGURE 2-1 FOR ALTERNATE)	70903	KHS-7041
W2					
W3	08445-60007	1	CABLE ASSY:INTERCONNECT	28480	08445-60007
W4	08445-20006	2	CABLE ASSY:RF COAXIAL (DELETE FOR OPTIONS 010 & 030)	28480	08445-20006
W4					
W5	08445-20006		CABLE ASSY:RF COAXIAL (DELETE FOR OPTIONS 010 & 030)	28480	08445-20006
W5					
W6	08445-20007	1	CABLE ASSY:RF COAXIAL (DELETE FOR OPTIONS 010 & 030)	28480	08445-20007
W6					
W7	08445-20008	1	CABLE ASSY:RF COAXIAL (DELETE FOR OPTIONS 010 & 030)	28480	08445-20008
W7					
XA5	08445-60013	1	(DELETE FOR OPTIONS 010 & 030) CONNECTOR:JUMPER	28480	08445-60013
XA5					
XA5	1251-0135	1	(DELETE FOR OPTIONS 020 & 030) CONNECTOR:BODY 15 PIN (OPTIONS.020 & 030)	28480	1251-0135
XA5					
XA5	5040-0051	1	HOOD:CONNECTOR (OPTIONS 020 & 030)	28480	5040-0051
XA5					

Table 6-3. Code List of Manufacturers

MFR NO.	MANUFACTURER NAME	ADDRESS	ZIP CODE
00300	U.S.A. COMMON	ANY SUPPLIER OF U.S.A.	
00779	AMP INC.(AIRCRAFT MARINE PROD.)	HARRISBURG, PA.	17101
01121	ALLEN BRADLEY CO.	MILWAUKEE, WIS.	53204
02660	AMPHENOL CORP.	BROADVIEW, ILL.	60153
02735	RCA SOLID STATE & RECEIVING TUBE DIV.	SOMERVILLE, N.J.	08876
04713	MOTOROLA SEMICONDUCTOR PROD.INC.	PHOENIX, ARIZ.	85008
07263	FAIRCHILD CAMERA & INST. CORP. SEMICONDUCTOR DIV.	MOUNTAIN VIEW, CALIF.	94040
13103	THERMALLOY CO.	DALLAS, TEX.	75247
24931	SPECIALTY CONNECTOR CO. INC.	INDIANAPOLIS, IND.	46227
26365	GRIES REPRODUCER CORP.	NEW ROCHELLE, N.Y.	10802
28480	HEWLETT-PACKARD COMPANY	PALO ALTO, CALIF.	94304
56289	SPRAGUE ELECTRIC CO.	N. ADAMS, MASS.	01247
70903	BELDEN CORP.	CHICAGO, ILL.	60644
71468	ITT CANNON ELECT. INC.	LOS ANGELES, CALIF.	90031
71785	CINCH MFG. CO. DIV TRW INC.	ELK GROVE VILLAGE, ILL.	
73734	FEDERAL SCREW PROD. INC.	CHICAGO, ILL.	60618
75915	LITTELFUSE INC.	DES PLAINES, ILL.	60016
76854	DAK MFG. CO. DIV. DAK ELECTRO/NETICS CORP.	CRYSTAL LAKE, ILL.	60014
77342	AMERICAN MACHINE & FOUNDRY CO. POTTER & BRUMFIELD DIV.	PRINCETON, IND.	47570
79727	CONTINENTAL-WIRT ELECTRONICS CORP.	PHILADELPHIA, PA.	19144
79963	ZIERICK MFG. CO.	MT. KISCO, N.Y.	10549
80131	ELECTRONIC INDUSTRIES ASSOCIATION	WASHINGTON D.C.	20006
91506	AUGAT INC.	ATTLEBORO, MASS.	02703
98978	INTERNATIONAL ELECT. RESEARCH CORP.	BURBANK, CALIF.	91502

SECTION VII MANUAL CHANGES

7-1. CURRENT INSTRUMENTS

7-2. This manual applies directly to Model 8445A Automatic Preselector having the following serial numbers: 1129A- and above.

7-3. OLDER INSTRUMENTS

7-4. The following changes have been made:

Serial prefixes 1119A- and below: Fuse A3F1 was not installed.

Serials 1119A00120 and below: A1R27 is 121K ohms, A1R28 is 5000 ohms.

7-5. NEWER INSTRUMENTS

7-6. As changes are made, newer instruments may have serial prefix numbers not listed in this manual. The manuals for these instruments will be supplied with an additional "Manual Changes" sheet containing the required information; contact your nearest Hewlett-Packard sales and service office for information if this sheet is missing.

SECTION VIII SERVICE

8-1. INTRODUCTION

8-2. This section provides instructions for troubleshooting and repair of the HP 8445A Automatic Preselector.

8-3. PRINCIPLES OF OPERATION

8-4. Information relative to the principles of operation appears on the foldout pages opposite the Block Diagram. Service Sheet 1. Theory of operation appears on the foldout pages opposite each of the foldout schematic diagrams. The schematic diagram circuits are referenced to the theory of operation text by block numbers.

8-5. RECOMMENDED TEST EQUIPMENT

8-6. Test equipment and accessories required to maintain the Preselector are listed in Table 1-3. If the equipment listed is not available, equipment that meets the required specifications may be substituted.

8-7. TROUBLESHOOTING

8-8. Troubleshooting procedures are divided into two maintenance levels in this manual. The first, a troubleshooting tree, is designed to isolate the cause of a malfunction to a circuit or assembly. In this procedure, maximum use is made of the front panel controls, indicators and the instrument's operating capability to isolate the malfunction to the defective circuit.

8-9. The second maintenance level provides circuit analysis and test procedures to aid in isolating faults to a defective component. Circuit descriptions and test procedures for the second maintenance level are located on the pages facing the schematic diagrams. The test procedures are referenced to the schematic diagrams by block numbers.

8-10. After the cause of a malfunction has been found and remedied in any circuit containing adjustable components, the applicable procedure specified in Section V of this manual should be performed. After repairs and/or adjustments have been made, the applicable procedure specified in Section IV of this manual should be performed.

8-11. REPAIR

8-12. Factory Repaired Exchange Modules. Factory repaired exchange modules are available

for modules that are not field-repairable. In addition, repaired exchange modules are available for major sub-assemblies as an alternate method of repair. The factory repaired modules are available at a considerable savings in cost over the cost of a new module.

8-13. These exchange modules should be ordered from the nearest Hewlett-Packard Sales/Service office using the part numbers in the replaceable parts table in Section VI of this manual. Virtually all orders for replacement parts received by HP offices are shipped the same day received — either from the local office or from a Service Center.

8-14. Factory Selected Components. Some component values are selected at the time of final checkout at the factory. Usually these values are not extremely critical; they are selected to provide optimum compatibility with associated components. These components, which are identified on the schematics with an asterisk, are listed in Table 8-1. The recommended procedure for replacing a factory-selected component is as follows:

- a. Try the original value, then perform the test specified in Section V of this manual for the circuit being repaired.
- b. If the specified test cannot be satisfactorily performed, try the typical value shown in the parts list and repeat the test.
- c. If the test results are still not satisfactory, substitute various values until the desired result is obtained.

8-15. Adjustable Components. Adjustable components, other than front panel operating controls, are listed in Table 8-2. Adjustment procedures for these components are contained in Section V of this manual.

Table 8-1. Factory Selected Components

Designation	Circuit	Purpose
A3R5	Yig Driver	Center TRACKING control

Table 8-2. Adjustable Components

Designation	Circuit	Purpose
A1R8	Harmonic Number Amplifier	Amplifier null
A1R23	n= + or - Amplifier	Amplifier null
A1R26	IF = 550 MHz/2.05 GHz Network	2050 MHz IF Offset
A1R28	IF = 550 MHz/2.05 GHz Network	550 MHz IF Offset
A1R31	Summing Amplifier	Amplifier null
A2R5	Power Supply	+19.5 Vdc Adjust
A2R20	Remote Control Amplifier	Common Differential Mode null
A2R21	Remote Control Amplifier	Common Differential Mode null
A2R23	Remote Control Amplifier	Amplifier null
A3R7	Yig Driver	Amplifier null/FREQ OFFSET control centering
A3R21	Yig Driver	18 GHz Breakpoint
A3R24	Yig Driver	15.5 GHz Breakpoint
A3R29	Yig Driver	12.5 GHz Breakpoint

8-16. Servicing Aids on Printed Circuit Boards.

Servicing aids on printed circuit boards include test points, transistor designations, adjustment callouts and assembly part numbers with alpha-numerical revision information.

8-17. Part Location Aids. The location of chassis mounted parts and major assemblies are shown in Figures 8-4 and 8-5.

8-18. The location of individual components mounted on printed circuit boards or assemblies are shown on the appropriate schematic. The part reference designator is the assembly designation plus the part designation. (Example: A1R1 is R1 on the A1 assembly.) For specific component description and ordering information refer to the replaceable parts table in Section VI.

8-19. Diagram Notes. Table 8-3, Schematic Diagram Notes, provides information relative to symbols and values shown on schematic diagrams.

8-20. GENERAL SERVICE HINTS

8-21. The etched circuit boards used in Hewlett-Packard equipment are the plated-through type consisting of metallic conductors bonded to both sides of an insulating material. The circuit boards can be either a single layer or multi-layer board. The metallic conductors are extended through the component holes or interconnect holes by a plating process. Soldering can be performed on either side of the board with equally good results. Table 8-4 lists recommended tools and materials for use in repairing etched circuit boards. Following are recommendations and precautions pertinent to

recommendations and precautions pertinent to etched circuit repair work.

a. Avoid unnecessary component substitution; it can result in damage to the circuit board and/or adjacent components.

b. Do not use a high power soldering iron on etched circuit boards. Excessive heat may lift a conductor or damage the board.

c. Use a suction device or wooden toothpick to remove solder from component mounting holes.

CAUTION

Do not use a sharp metal object such as an awl or twist drill for this purpose. Sharp objects may damage the plated-through conductor.

d. After soldering, remove excess flux from the soldered areas and apply a protective coating to prevent contamination and corrosion.

8-22. Component Replacement. The following procedures are recommended when component replacement is necessary:

a. Remove defective component from board.

b. If component was unsoldered, remove solder from mounting holes with a suction device or a wooden toothpick.

c. Shape leads of replacement component to match mounting hole spacing.

Table 8-3. Schematic Diagram Notes

SCHEMATIC DIAGRAM NOTES

Refer to USAS Y32.2 - 1967

Resistance is in ohms, capacitance is in microfarads, and inductance in millihenries unless otherwise noted.

P/O = part of.

*Asterisk denotes a factory-selected value. Value shown is typical. Capacitors may be omitted or resistors jumpered.



Screwdriver adjustment.



Panel control.



Encloses front panel designations.



Encloses rear panel designation.

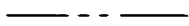

Circuit assembly borderline.

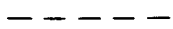

Other assembly borderline.



Heavy line with arrows indicates path and direction of main signal.



Heavy dashed line with arrows indicates path and direction of main feedback.



Wiper moves toward CW with clockwise rotation of control as viewed from shaft or knob.



Numbers in stars on circuit assemblies show locations of test points.



Encloses wire color code. Code used (MIL-STD-681) is the same as the resistor color code. First number identifies the base color, second number the wider stripe, and the third number identifies the narrower stripe. E.g., (947) denotes white base, yellow wide stripe, violet narrow stripe.

$n=1 \pm *$

n = harmonic number

1 = 1st LO fundamental

\pm = 1st LO above or below 1st IF

* = 550 MHz 1st IF; no asterisk = 2050 MHz 1st IF.



Letter = off page connection.

Number = Service Sheet location for off page connection.

d. Insert component leads into mounting holes and position component as original was positioned. Do not force leads into mounting holes: sharp lead ends may damage the plated-through conductor.

Note

Although not recommended when both sides of the circuit board are accessible, axial lead components such as resistors and tubular capacitors, can be replaced without unsoldering. Clip leads near body of defective component, remove component and straighten leads left in board. Wrap leads of replacement component one turn around original leads. Solder wrapped connection and clip off excess lead.

8-23. GENERAL SERVICE INFORMATION

8-24. Transistors and diodes are used throughout the Preselector in circuit configurations such as delay circuits, trigger circuits, switches, oscillators and various types of amplifiers. Basic transistor operation is shown in the following pages.

8-25. Transistor In-Circuit Testing. The common causes of transistor failure are internal short circuits and open circuits. In transistor circuit testing, the most important consideration is the transistor base-to-emitter junction. The base emitter junction in a transistor is comparable to the control grid-cathode relationship in a vacuum tube. The base emitter junction is essentially a solid-state diode; for the transistor to conduct, this diode must be forward biased. As with simple diodes, the forward-bias polarity is determined by the materials forming the junction. Transistor symbols on schematic diagrams reveal the bias polarity required to forward-bias the base-emitter junction. The B part of Figure 8-1 shows transistor symbols with the terminals labeled. The other two columns compare the biasing required to cause conduction and cut-off in NPN and PNP transistors. If the transistor base-emitter junction is forward biased, the transistor conducts. However, if the base-emitter junction is reverse-biased, the transistor is cut off (open). The voltage drop across a forward-biased, emitter-base junction varies with transistor collector current. For example, a germanium transistor has a typical forward-bias, base-emitter voltage of 0.2–0.3 volt when collector current is 1–10

Table 8-4. Etched Circuit Soldering Equipment

Item	Use	Specification	Item Recommended
Soldering tool	Soldering Unsoldering	Wattage rating: 47 ¹ / ₂ – 56 ¹ / ₂ Tip Temp: 850–900 degrees	Ungar No. 776 handle with *Ungar No. 4037 Heating Unit
Soldering* Tip	Soldering Unsoldering	*Shape: pointed	*Ungar No. PL111
De-soldering aid	To remove molten solder from connection	Suction device	Soldapult by Edsyn Co., Arleta, California
Resin (flux)	Remove excess flux from soldered area before application of protective coating.	Must not dissolve etched circuit base board material or conductor bonding agent	Freon, Aceton, Lacquer Thinner, Isopropyl Alcohol (100% dry)
Solder	Component replacement Circuit board repair Wiring	Resin (flux) core, high tin content (60/40 tin/lead), 18 gauge (SWG) preferred	
Protective Coating	Contamination, corrosion protection.	Good electrical insulation, corrosion-prevention properties	Krylon ** No. 1302 Humiseal Protective Coating, Type 1B12 by Columbia Technical Corporation, Woodside 77, New York
<p>*For working on etched Boards: for general purpose work, use Ungar No. 1237 Heating Unit (37.5W, tip temperature of 750–800 degrees) and Ungar No. PL113, 1/8 inch chisel tip.</p> <p>**Krylon, Inc., Norristown, Pennsylvania</p>			

mA, and 0.4–0.5 volt when collector current is 10–100 mA. In contrast, forward-bias voltage for silicon transistors is about twice that for germanium types; about 0.5–0.6 volt when collector current is low, and about 0.8–0.9 volt when collector current is high.

8-26. Figure 8-1, Part A, shows simplified versions of the three basic transistor circuits and gives the characteristics of each. When examining a transistor stage, first determine if the emitter-base junction is biased for conduction (forward-biased) by measuring the voltage difference between emitter and base. When using an electronic voltmeter, do not measure directly between emitter and base; there may be sufficient loop current between the voltmeter leads to damage the transistor. Instead, measure each voltage separately with respect to a common point (e.g., chassis). If the emitter-base junction is forward-biased, check for amplifier action by short-circuiting base to emitter while observing collector voltage. The short circuit eliminates base-emitter bias and should cause the transistor to stop conducting (cut off). Collector voltage should then change and approach the supply voltage. Any difference is due to leakage current through the transistor and, in general, the smaller this current the better the transistor. If the collector voltage does not change, the transistor has either an emitter-collector short circuit or emitter-base open circuit.

8-27. Transistor and Diode Markings. Figure 8-2 illustrates examples of diode and transistor mark-

ing methods. In addition, the emitter lead for bipolar transistors is identified on the printed circuit boards.

8-28. OPERATIONAL AMPLIFIERS

8-29. Operational amplifiers are used to provide such functions as summing amplifiers, offset amplifiers, buffers and power supplies. The particular function is determined by the external circuit connections. Equivalent circuit and logic diagrams for type 741 operational amplifiers are contained in Figure 8-3. Circuit A is a non-inverting buffer amplifier with a gain of 1. Circuit B is a non-inverting amplifier with gain determined by the resistance of R1 and R2. Circuit C is an inverting amplifier with gain determined by R1 and R2, with the input impedance determined by R2. Circuit D contains the functional circuitry and pin connection information along with an operational amplifier review.

Note

In Circuit D it is assumed that the amplifier has high gain, low output impedance and high input impedance.

8-30. Operational Amplifier Troubleshooting Procedure. Measure and record the voltage level at both the – (inverting) terminal pin 2 and the + (non-inverting) terminal pin 3. The level should not differ by more than ≈ 10 mV. If the voltage level is not within ≈ 10 mV, check the

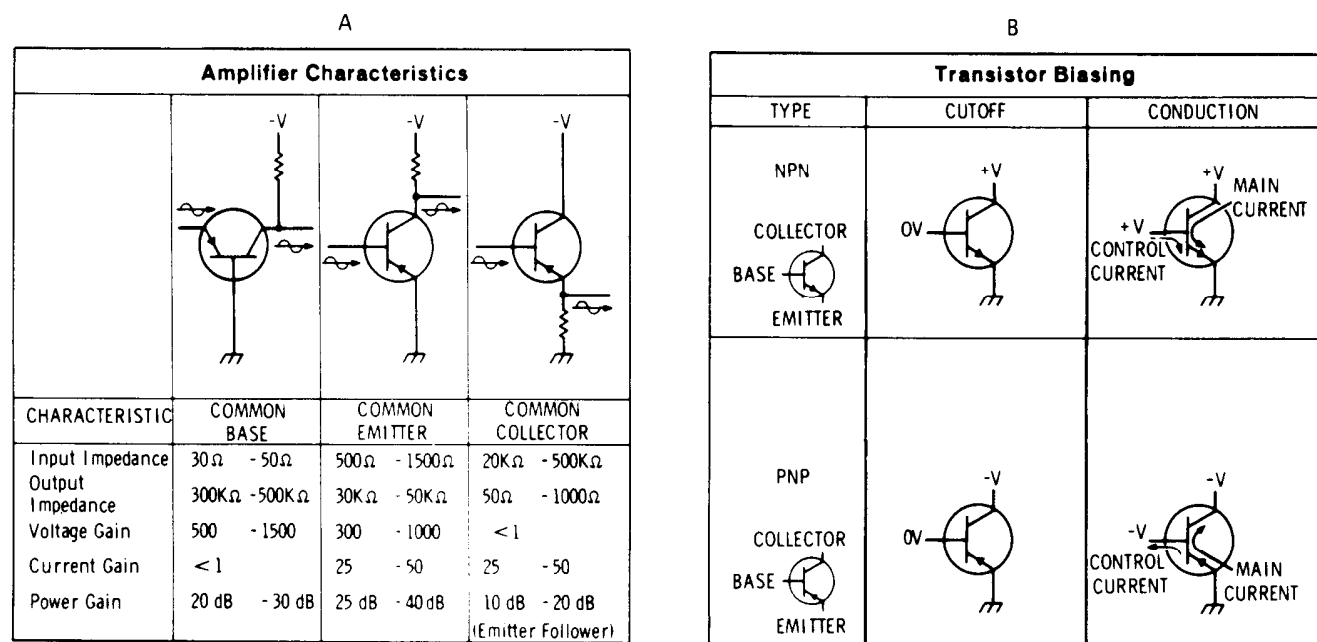

Figure 8-1. Transistor Operation

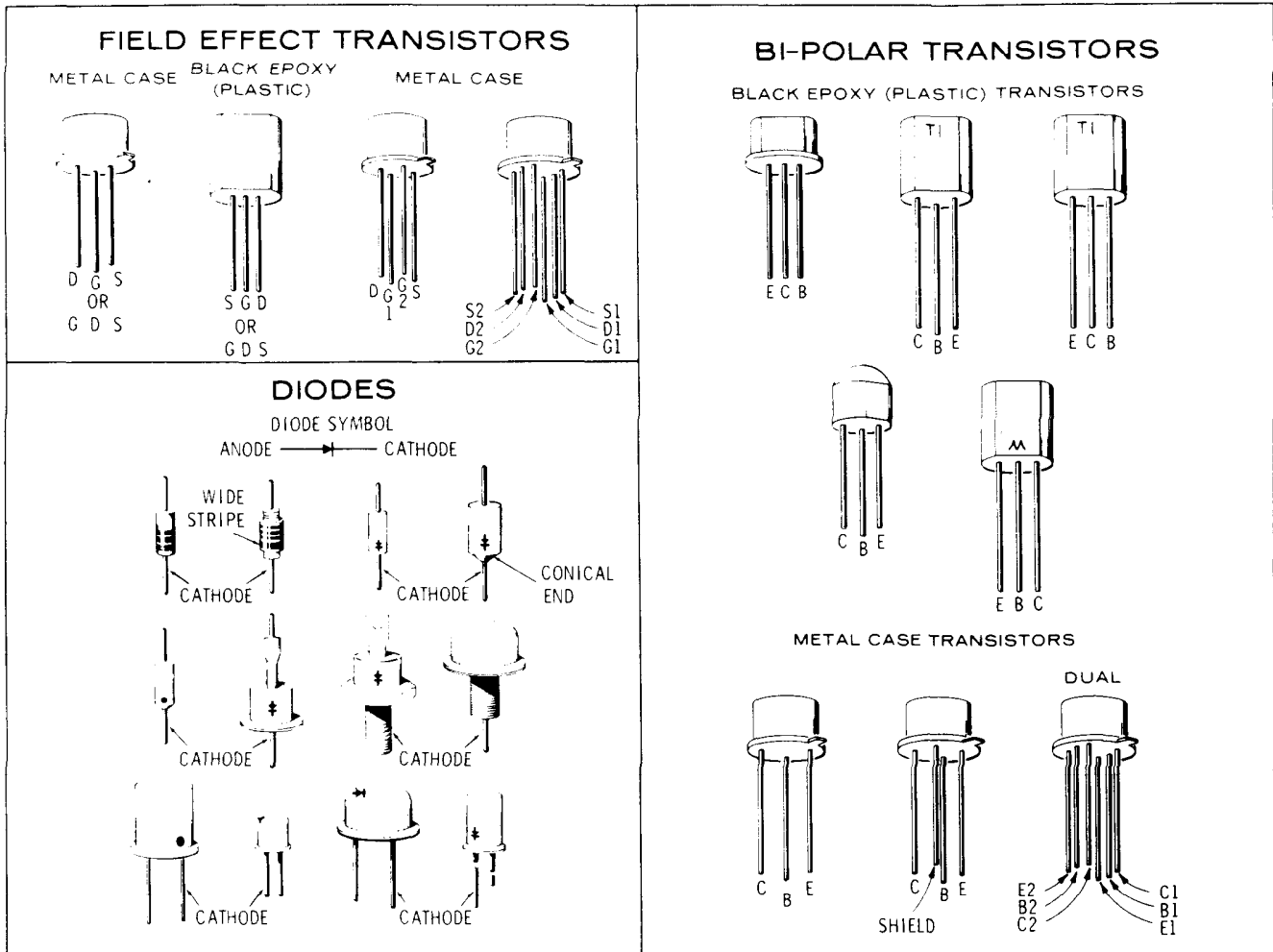

Figure 8-2. Examples of Diode and Transistor Marking Methods

external circuitry and components. If the external circuitry (input signal, operating voltages, feedback resistors) is normal, replace the operational amplifier.

8-31. ELECTRICAL MAINTENANCE

8-21. Perform the electrical checks and adjustments once every six months and after repair or component replacement.

8-33. MECHANICAL MAINTENANCE

8-34. Inspect the air filter at the rear of the instrument frequently and clean it before air flow is restricted. To clean the filter, wash thoroughly in warm water and detergent. Air dry filter before installing it on the instrument.

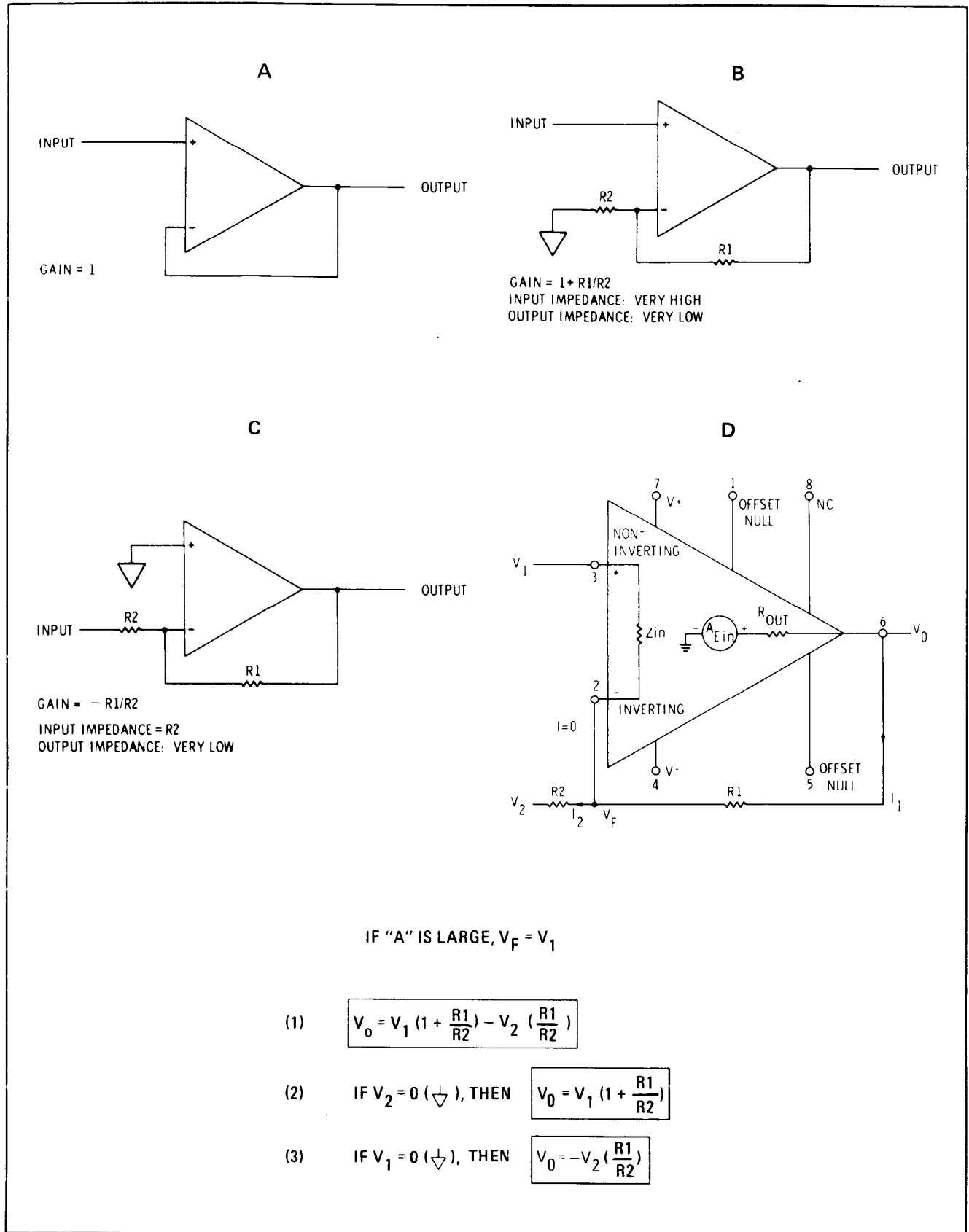

Figure 8-3. Operational Amplifier Equivalent Circuit

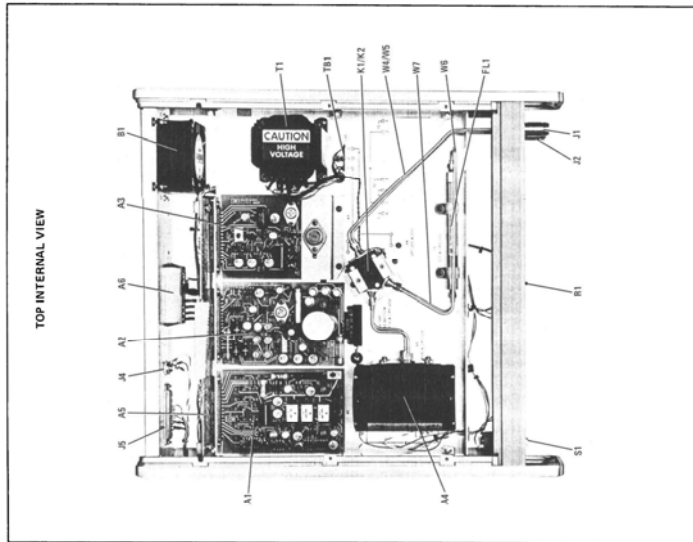

Figure 8-4a. 8445A Preslector Top Internal View

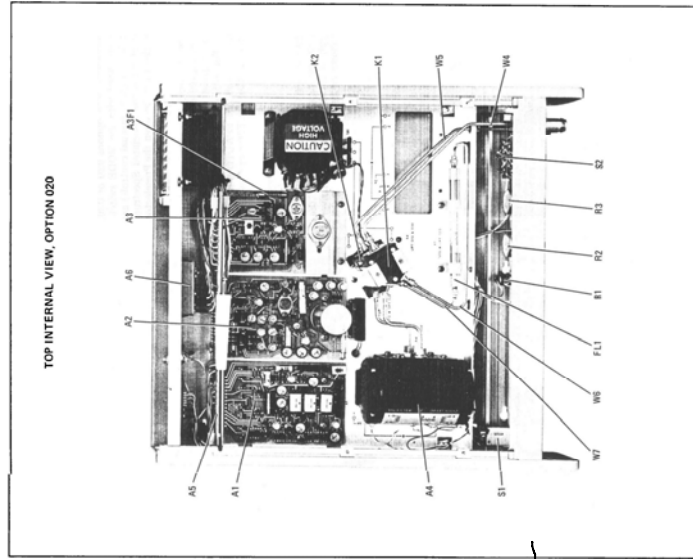

Figure 8-4b. 8445A Option 020 Preslector, Top Internal View

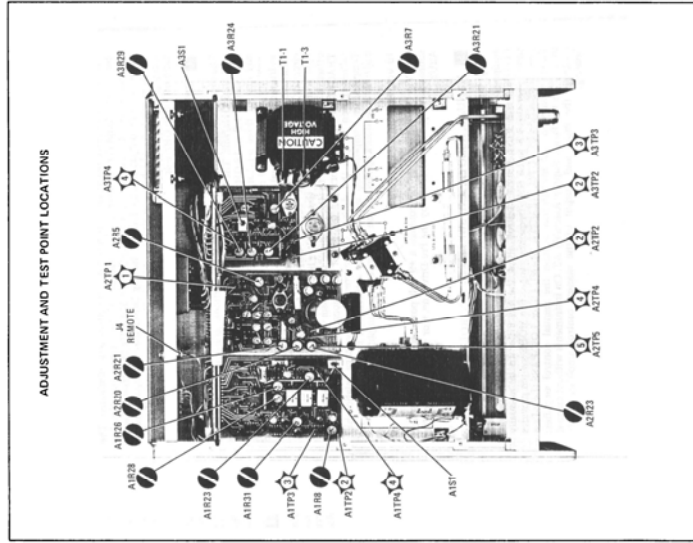

Figure 8-5. Adjustment and Test Point Locations

SERVICE SHEET 1 (cont'd)

Band Code bit "0" from the analyzer. The output is a voltage proportional to the analyzer's 1st IF offset. The frequency-to-voltage ratio is 1.025 GHz/Volt. The Pre-Driver Retrace Sense Amplifier is triggered by the -5 to +5 volt PER DIVISION sweep signal on the Stop and Line signals. When the Retrace Sense Amplifier is applied to the Yig Reset Amplifier, during retrace the output of the Yig Reset Amplifier causes the Summing Amplifier to change the voltage level of the Yig Driver equal to a 100 MHz frequency. The hysteresis effects in the filter magnetic core structure are effectively eliminated. The Summing Amplifier combines the output of the Harmonic Number Amplifier with the output of the Retrace Sense Amplifier to produce an output voltage level to the Yig Driver that is proportional to the frequency to which the analyzer is tuned. The Summing Amplifier has unity gain (-2) with an output voltage level proportional to frequency by a ratio of 1.025 GHz/volt.

4 YIG DRIVER

The input to the Yig Driver is a voltage proportional to frequency by a ratio of 1.025 GHz/volt. The Yig Driver output is a current that tunes the Yig Filter from 1.8 to 18 GHz. The input to the Yig Driver can be supplied from any one of the separate control circuits. The Yig Driver is used in all instruments with manual control. Switching is automatic except for instruments with manual control. Refer to Service Sheet 5 for switching information. Two front panel controls are associated with the Yig Driver circuitry. The Yig Driver is controlled by the Yig Filter current-frequency curve. The offset is due primarily to the residual magnetism in the core structure. TRACKING control corrects for minor variations in circuit component values. Temperature compensation is provided by a thermistor installed in the Yig Filter with feedback applied to the Yig Driver input amplifier.

+9 Volt Reference

The Yig Driver Assembly A3 contains a +9 volt power supply. The +9 volt supply is used as a reference by the Pre-Driver A4 or Offset Amplifier A212.

3 MANUAL, REMOTE, AND SWITCHING CONTROL CIRCUITRY

a. Manual Control Circuitry. Instruments with options 020 or 030 are equipped with manual front panel tuning controls and a mode switch. COARSE and FINE tuning controls allow the Yig Filter to be manually tuned. The MODE switch is used to select the MODE of the Yig Driver (manual section of AUTO, REMOTE, MANUAL, or LOW-PASS Low-Pass Filter) operation. All instruments contain the manual control amplifier, located on the Power Supply Assembly A2. On instruments without manual control, the input and output of the manual control amplifier is left floating.

SERVICE SHEET 1 (cont'd)

b. Remote Control Circuitry. All instruments are equipped with provisions for remote tuning of the Yig Filter by an external voltage source. The REMOTE control circuitry is controlled by the Yig Filter current-frequency tuning ratio of 1 GHz/volt. A remote control amplifier (located on the Power Supply Assembly A2) inverts and conditions the remote input signal. The remote control amplifier is used to tune the Yig Filter. The selection of the REMOTE control is accomplished with the MODE switch. Instruments other than options 020 or 030 (without manual controls) are automatically switched to REMOTE input when the associated Spectrum Analyzer is connected to the analyzer by connecting cable between the Preselector and Spectrum Analyzer is removed.

c. Switch Control Circuitry. The switch control circuitry consists of the manual control circuitry and the remote control circuitry. The manual control switching circuitry is controlled by Band Code signals from the 8555A Spectrum Analyzer RF Section. For instruments without manual controls and for instruments with manual controls set to AUTO position, the Band Code signals determine the selection of the Yig Filter or Low-Pass Filter.

3 POWER SUPPLY ASSEMBLY A2

Refer to Service Sheet 6 for the -23, +19.5 and +40 volt power supplies. In addition to the three supplies above, a +9 volt supply is required by the Yig Driver Assembly A3 with the schematic diagrams shown on Service Sheet 4.

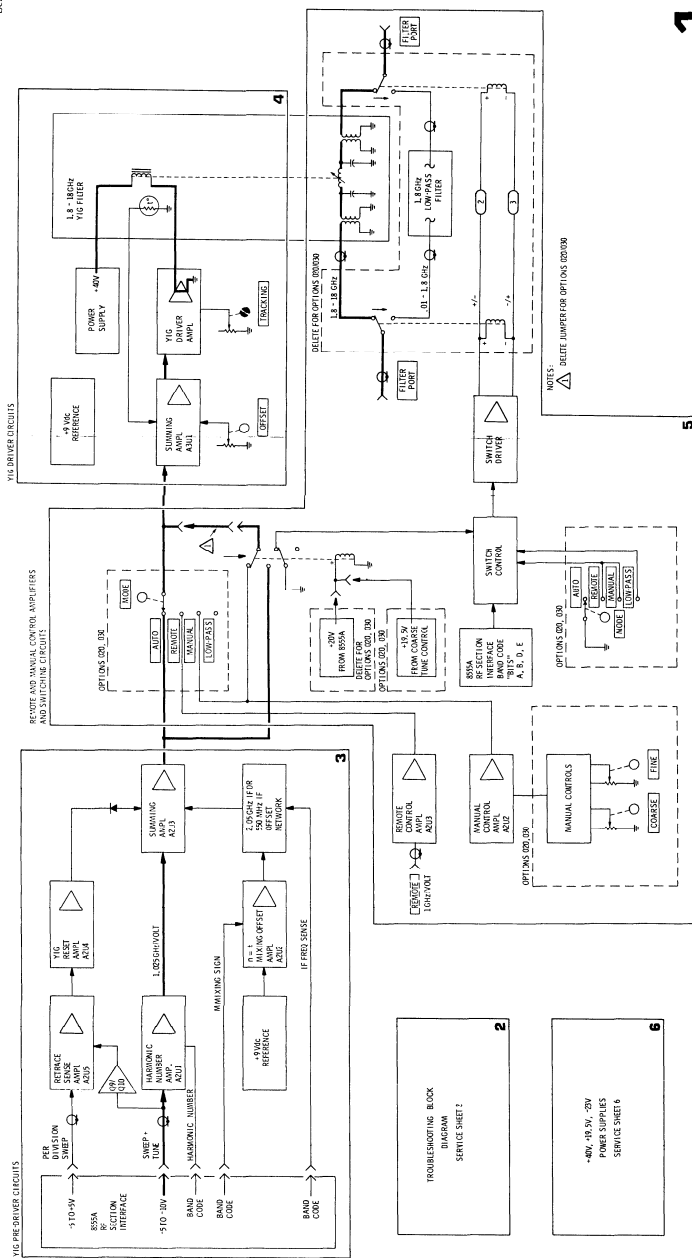

Figure 8-6. Preselector Block Diagram 8-11

SERVICE SHEET 2

PRESELECTOR TROUBLESHOOTING PROCEDURE

A malfunction in the Preselector or Interconnect Cable can affect operation of the Spectrum Analyzer. Likewise, a malfunction in the Spectrum Analyzer can affect Preselector operation. Before troubleshooting either instrument, disconnect Preselector from the Spectrum Analyzer. If the Preselector does not operate satisfactorily, proceed with the Preselector troubleshooting procedure.

Maximum utilization of the Preselector's operating capability should be made to isolate the fault. Use the following procedure to switch the instrument to the MANUAL operating MODE and tuned over the instrument's operating range. Instruments without manual controls can be used to tune the Preselector and the Spectrum Analyzer. Connect the dc source to the REMOTE input. A voltage at the REMOTE input tunes the Yig filter at a ratio of 11 GHz/volt.

TEST EQUIPMENT REQUIRED

- Spectrum Analyzer: HP 8555A/8550/1140
- Digital Voltmeter: HP 3457A
- Oscilloscope: HP 180A/1801A/1821A
- Frequency Comb Generator: HP 8405A

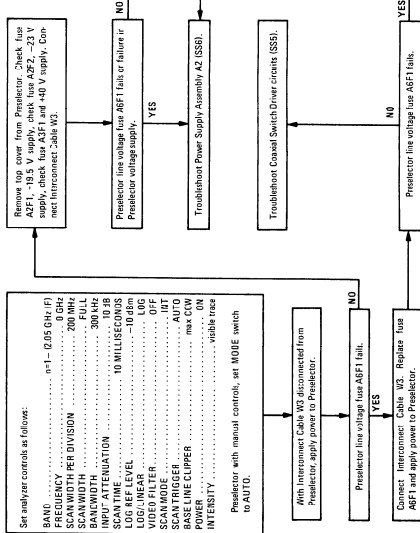

Service

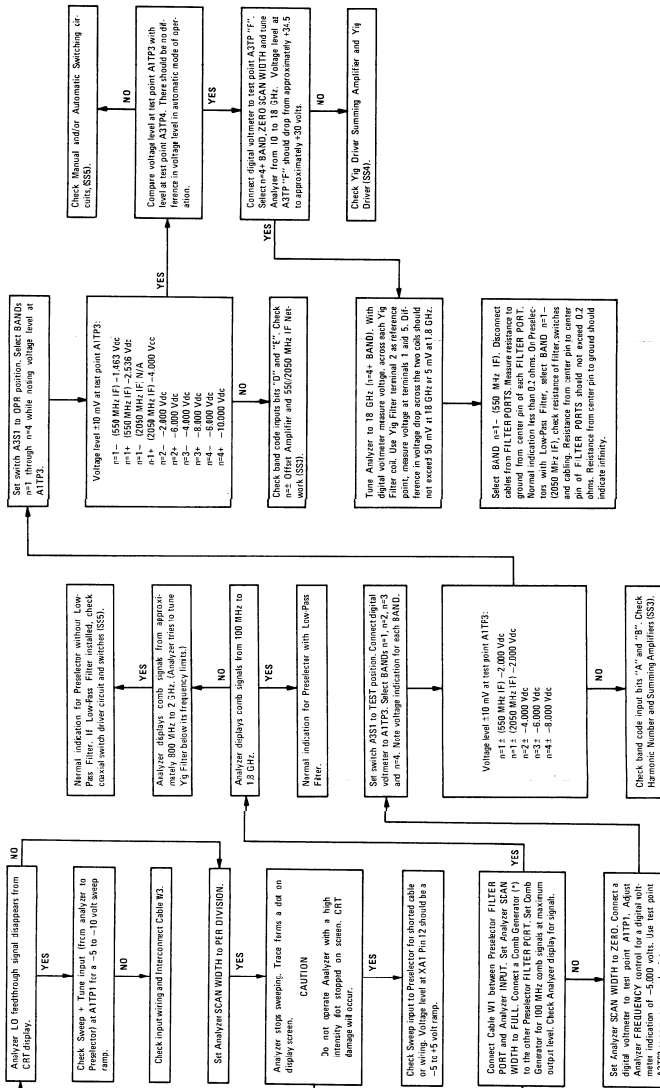

(1) Signal source or receiver capable of producing a -30 dBm signal over the frequency range of 10 MHz to 2.0 GHz.

TROUBLESHOOTING PROCEDURE

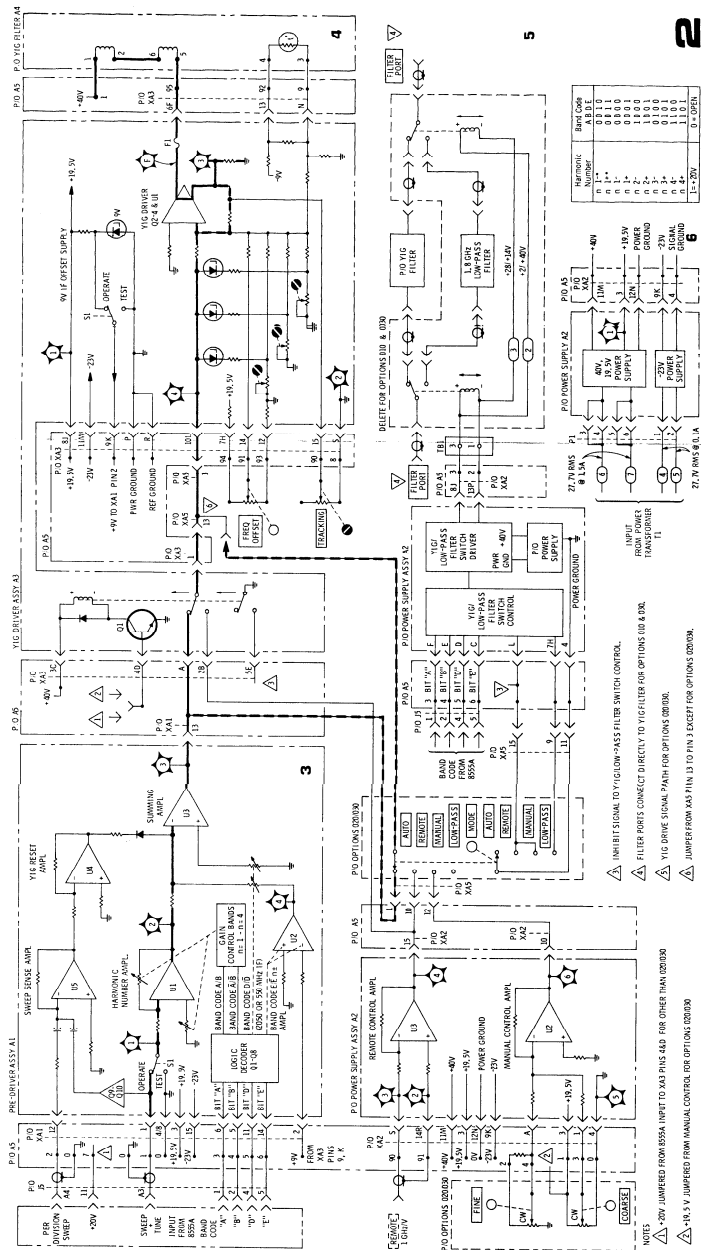

Figure 8-7. Preselector Troubleshooting Block Diagram

SERVICE SHEET 3

THEORY OF OPERATION

PRE-DRIVER ASSEMBLY A1

Service Sheet 3 contains the schematic diagram for the Pre-Driver Assembly A1. The Pre-Driver converts the sweep, sweep + tune and band code signals from the 8555A RF Section to a voltage that is proportional to the frequency to be amplified. The Pre-Driver consists of a harmonic number amplifier, a sweep sense amplifier, a sweep sense and logic decoder/relay driver circuit.

HARMONIC NUMBER AMPLIFIER

The harmonic number amplifier AIU1 multiplies the sweep + tune voltage by a factor of (n x -0.1). The sweep + tune voltage is proportional to the harmonic number. The output of AIU1 is a voltage that is proportional to the harmonic number. The output of AIU1 is a voltage that is proportional to the harmonic number.

n+ or - AMPLIFIER

The n+ or - amplifier AIU2 provides an offset voltage to match the n+ or - mixing mode in the RF Section. A +9.0 Vdc reference voltage from Yig Driver Assy A3, applied to the amplifier, provides a -9.0 Vdc level for the minus mixing mode and a +9.0 Vdc level for the plus mixing modes. The positive or negative voltage is controlled by band code bit "E" from the RF Section.

IF = 550 MHz or 2.05 GHz NETWORK

The 550 or 2.05 GHz network provides a voltage offset equivalent to the first IF frequency in the Analyzer RF Section. The relative network is driven by either +9 or -9 Vdc from the n+ or - amplifier and provides an output of either +0.37 or -2.000 volts at the output of summing amplifier AIU3. The output of AIU3 is a voltage that is proportional to the harmonic number. AIU3 (ADJ 4) adjusts the 2060 MHz IF offset and AIU3 (ADJ 5) adjusts the 550 MHz offset.

SUMMING AMPLIFIER

Summing amplifier AIU3 combines the output from the harmonic number amplifier, the output from the n+ or - amplifier, and the output from the Yig Driver Assembly A3 (Service Sheet 4). The output from the summing amplifier is applied to the Yig Driver Assembly A3 (Service Sheet 4).

SWEEP SENSE AND YIG FILTER HYSTERESIS RESET AMPLIFIERS

Sweep sense amplifier AIU5 is triggered by the negative going edge of the sweep in the FULL or TRACK mode. When the Jumper is operating in the PER DIVISION mode, AIU5 senses the falling edge of the sweep signal and provides a negative going output to approximately AIU3. AIU5 also senses the falling edge of the sweep signal and provides a negative going output to approximately AIU3. AIU5 also senses the falling edge of the sweep signal and provides a negative going output to approximately AIU3. AIU5 also senses the falling edge of the sweep signal and provides a negative going output to approximately AIU3.

SERVICE SHEET 3 (cont'd)

starting frequency, the hysteresis effect in the magnetic core structure is effectively eliminated.

LOGIC DECODERS/RELAY DRIVERS

Transistors A01 through A08 and their associated circuitry perform the logic decoder and relay driver functions. Band code signals from the RF Section are utilized to control switching in the circuit. The harmonic number amplifier, the n+ or - amplifier, and the IF = 550 MHz or 2.05 GHz network are either a +20 volt level or open circuit (-12 volts through a high resistance).

TROUBLESHOOTING PROCEDURE

PRE-DRIVER ASSEMBLY A1

When a malfunction has been isolated to the Pre-Driver Assembly A1 or to isolate a malfunction in the assembly, perform the following procedure. Connect Preslector to Analyzer, apply power and allow at least 20 minutes for the magnetic core to warm up and stabilize. Make all voltage measurements in reference to A1P2 (common ground point).

Table with 2 columns: EQUIPMENT REQUIRED and Part Numbers (e.g., HP 8555A, HP 2480B, HP 180A).

HARMONIC NUMBER AMPLIFIER

Set switch A81 to "test" position. Measure at A1P2 for a level of 0 Vdc. Set switch A81 to "operate" position. Connect voltmeter to A1P2. Set switch A81 to "operate" position. Connect voltmeter to Spectrum Analyzer. Adjust analyzer FREQUENCY control for an indicated voltage level of -5.000 Vdc -1 mV at A1P1. Connect voltmeter to A1P2 and check for a level of -0.000 Vdc +/- 2 mV. Select analyzer bandpass and n-4; for +8.000 Vdc +/- 5 mV Amplifier AIU1 gain = (n x -0.4) with "n" controlled by Logic Decoder/Relay Drivers (see 6 below). See paragraph 8-30 for Operational Amplifier troubleshooting procedure. If voltages are out of tolerance see paragraph 5-9 for adjustment procedure.

n+ or - AMPLIFIER

Set Yig Driver Assy switch A81 to "test" position and check voltage at test point A1P4 for a level of 0 Vdc +/- 1 mV. Set switch A81 to "operate" position and select n=1 - 650 MHz (F) BAND on analyzer. Check voltage at A1P4 for a level of +9.0 Vdc +/- 2 mV. Select analyzer bandpass and BAND. Check for a +9.0 Vdc level at A1P4. Switch analyzer through BANDS n=1 - to n=4+. Voltage readings should be within 2 mV with a positive polarity on n+ bands and negative polarity on n- bands. Check for a +9.0 Vdc level at A1P4. Switch analyzer through BANDS n=1 - to n=4+. Voltage readings should be within 2 mV with a positive polarity on n+ bands and negative polarity on n- bands. See paragraph 8-30 for Operational Amplifier troubleshooting procedure. If voltages are out of tolerance see paragraph 5-9 for adjustment procedure.

SERVICE SHEET 3 (cont'd)

IF = 550 MHz/2.05 GHz NETWORK AND SUMMING AMPLIFIERS

Set switches A81 and A81 to "test" position. Measure voltage at A1P2 for a level of 0 Vdc +/- 1 mV. Set switches A81 and A81 to "operate" position and connect voltmeter to A1P2. Set analyzer to n=1 - (550 MHz ZERO SWEEP WIDTH and adjust FREQUENCY for a voltage level indicated level of -1.463 Vdc +/- 2 mV. Select n=1 - (550 MHz (F) BAND and check for an indicated voltage level of -2.536 Vdc +/- 2 mV at A1P3. Select n=1 - (550 MHz (F) BAND and check for an indicated voltage level of -2.536 Vdc +/- 2 mV at A1P3. Select n=2+ BAND and check for an indicated voltage level of -6.000 Vdc +/- 3 mV at A1P3. The 550 MHz or 2.05 GHz IF offset is controlled by Band Code "bit" D. See Item 6 below. See paragraph 8-30 for Operational Amplifier troubleshooting procedure. If voltages are out of tolerance see paragraph 5-9 for adjustment procedure.

SWEEP SENSE AND YIG FILTER HYSTERESIS RESET AMPLIFIERS

Check the sweep sense and Yig filter hysteresis reset amplifiers using an oscilloscope under the conditions listed below.

- a. Set Spectrum Analyzer controls as follows: FREQUENCY: n+1 (2.05 GHz (F) BAND) BANDWIDTH: 200 MHz SCAN WIDTH PER DIVISION: 10 MILLISECONDS SCAN MODE: LINE SCAN TRIGGER: DC Coupled INPUT: 20 MSEC TIME/DIV: NEXT TRIGGER: VOLTS/DIV: 5
- b. Set Oscilloscope controls as follows: DC Coupled TIME/DIV: 20 MSEC TRIGGER: NEXT TRIGGER: VOLTS/DIV: 5
- c. Connect SCAN IN/OUT on analyzer to external trigger input on oscilloscope.
- d. Connect oscilloscope probes to A1P3 and A1U5 pin 6 (TP "A") and compare with typical waveforms given below.
- e. If normal, connect oscilloscope probes to A1P3 and A1P5. Compare with typical waveforms given below.
- f. If abnormal, switch analyzer to FULL scan mode and repeat steps d and e above.
- g. See paragraph 8-30 for operational amplifier troubleshooting procedure.

SERVICE SHEET 3 (cont'd)

LOGIC DECODER/RELAY DRIVERS

Check the logic decoder/relay drivers using the table below.

Table with columns: Analyzer Number, Band Code (A, B, D, E), Relay (A1K1, A1K2, A1K3, A1K4, A1K5), and Relay status (closed, open).

Band Code "bit": 1 = +20 Vdc, 0 = open circuit (approximately -13 Vdc)

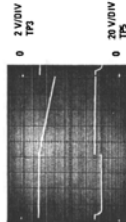
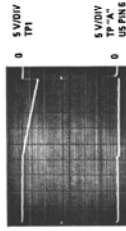

Figure 8-8. Hysteresis Reset Circuit Waveforms

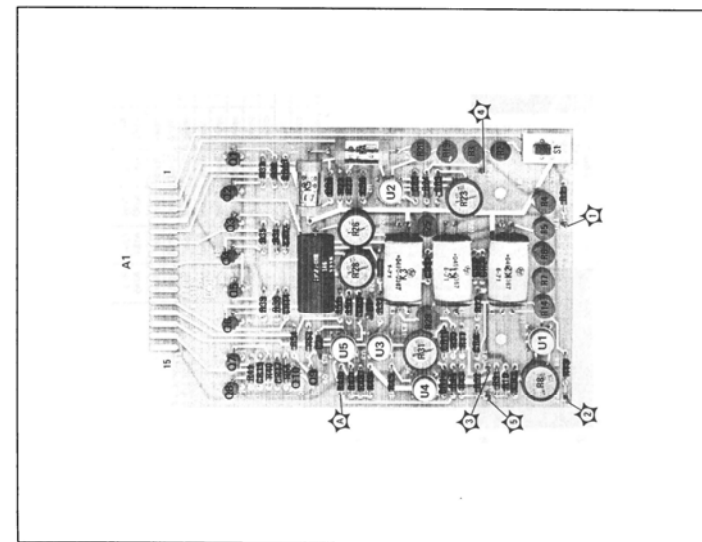

Figure 8-9. Pre-Driver Assembly A1, Component Location

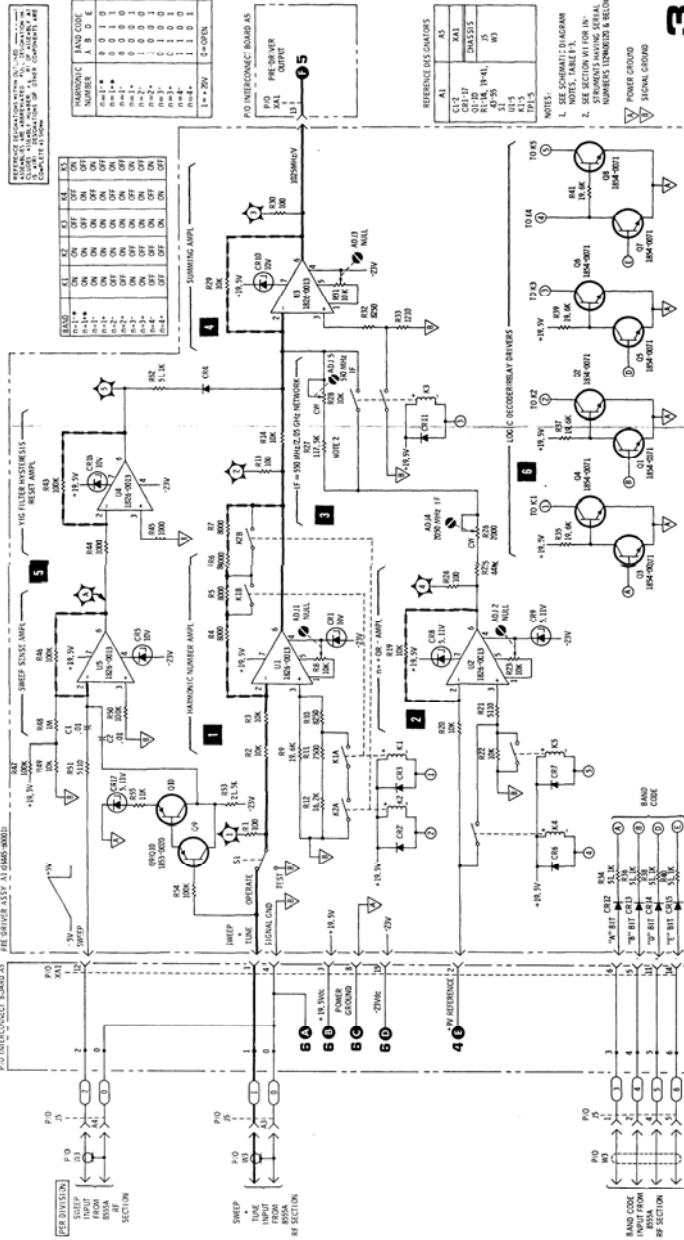

Figure 8-10. Pre-Driver Assembly A1, Schematic Diagram

SERVICE SHEET 4

THEORY OF OPERATION

Service Sheet 4 contains the schematic diagram for the Automatic Switching Control circuit, +9 Volt -F Offset Supply and the Yig Driver.

1 AUTOMATIC SWITCHING CONTROL

See Service Sheet 5.

2 +9 VOLT IF OFFSET SUPPLY

Resistor A3R10 and breakdown diode A3CR5 form a diode regulated +9 volt power supply. The +9 volt source is utilized by the n+ or - amplifier A1U2 to provide an IF frequency offset. Switch A3S1 is provided for test and adjustment purposes.

3 YIG DRIVER

The Yig driver consists of operational amplifier A3U1, transistors A3Q2, Q3 and Q4, and their associated components. The input voltage to the Yig driver is 10 mV. The Yig driver output is a current proportional to the input voltage. The linear current-frequency curve of the Yig filter, the current-to-frequency ratio of the Yig filter is 25.3 MHz/mA with an offset of 25.8 MHz. The linear current-frequency curve of the Yig filter produces a current that is equal to the following equation:

$$I_{mA} = \frac{MHz - 25.8}{25.8}$$

where MHz = 1095 x V_{input} to Yig driver.

The current required to tune the Yig filter varies from approximately 70 mA at 2 GHz to 700 mA at 18 GHz. Figure 8-11 is a simplified schematic of the Yig drive and Yig filter coil. The negative input voltage is inverted by U1. The current through the Yig filter coil is approximately 70 mA. The current increases until the current through R6 exactly balances the currents through R3 and R4. Circuit values are chosen to give the desired coil current-to-frequency ratio. The TRACONC is a current-to-frequency converter provided as an adjustment to correct for the frequency offset. The PEAO OFFSET is provided as an adjustment to correct for the offset due to residual magnetism in the core structure.

a. Temperature Compensation. At the temperature of the Yig filter rises, the resonant frequency tends to decrease at a rate of approximately 3 MHz/°C. An increase in temperature decreases the resistance of thermistor A3R10. The Yig driver output is a current proportional to the input voltage. The amplifier output then goes positive, which raises the Yig frequency, compensating for the drop caused by increasing temperature. A simplified schematic of the temperature compensation circuit is shown in Figure 8-12. This circuit gives some offset current. This offset is removed by the offset compensation circuit, having only the changes from 25°C to be corrected by the temperature compensation circuit.

b. Linearity Correction Breakpoints. In practice, the Yig coil does not exhibit a linear current-frequency characteristic; the iron core tends to saturate at the higher frequencies. To compensate for the non-linear curve, compensating breakpoints are added to the driver circuit. Figure 8-13 is a

SERVICE SHEET 4 (cont'd)

simplified drive circuit with one breakpoint. For a voltage input smaller than 10 mV, the current through the Yig filter coil is approximately 70 mA. As the voltage input exceeds 10 mV, the diode conducts, causing some current to flow through R3. This demands more current to flow through R6 which raises the voltage at TP3. The current through R6 increases until the current through R6 exactly balances the current through R3 and R4. The voltage where the diodes conduct, breakpoints are created, and the slope of the curve is changed by varying the 20K resistor. The current through R6 is adjustable by varying the 20K resistor. The current through R6 is adjustable by varying the 20K resistor (linear operation).

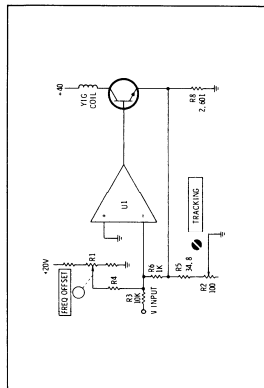

Figure 8-11. Simplified Yig Driver Circuit

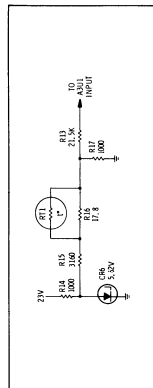

Figure 8-12. Simplified Temperature Compensation Circuit

SERVICE SHEET 4 (cont'd)

TROUBLESHOOTING PROCEDURE

YIG DRIVER ASSEMBLY A3

When a malfunction has been isolated to the Yig driver, check the following: 1. Connect Preslector to Analyzer, supply power and allow equipment to warm up and stabilize. Make all reference to A3TP2 (common ground point). EQUIPMENT REQUIRED:

- 8555A Spectrum Analyzer HP 8
- Digital Voltmeter R

1 +9 VOLT IF OFFSET SUPPLY

Set switch A3S1 to TEST position and check for a voltage at TP10 (junction of A3R10 and A3CR5) and A3CR5. If voltage is correct, circuit wiring is correct.

2 YIG DRIVER TROUBLESHOOTING

Set Analyzer controls as follows:

- BAND n-1
- FREQUENCY 10 N
- SCAN WIDTH 10 N
- SCAN TIME 10 N
- SCAN TRIGGER

On Preslector, check fuse A3F1. Connect digital voltmeter to TP10 (junction of A3R10 and A3CR5) and A3CR5. Voltage level at test point F should indicate appropriate level. At test points, check the input level at pins 2 and 3 of A3U1 between the level at pin 2 and at pin 3 should not exceed 10 mV at the input to A3U1 is determined by the A3R7. Amplifier A3U1 can be isolated from the A3R7. Fuse A3F1 and the jumper connecting a jumper from A3R7 to A3U1. If voltage level differs by more than 25 mV, A3U1. If A3R7 has little or no effect, replace A3U1. If A3R7 has little or no effect, replace A3U1. A transistor or diode will normally cause fuse A3F1 to

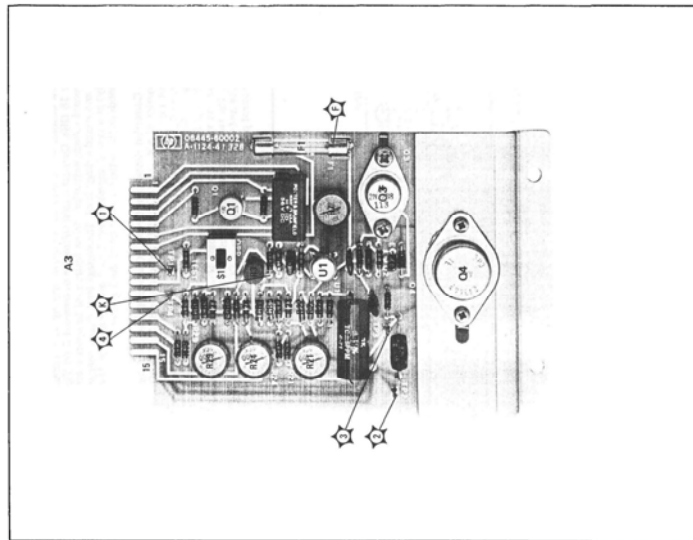
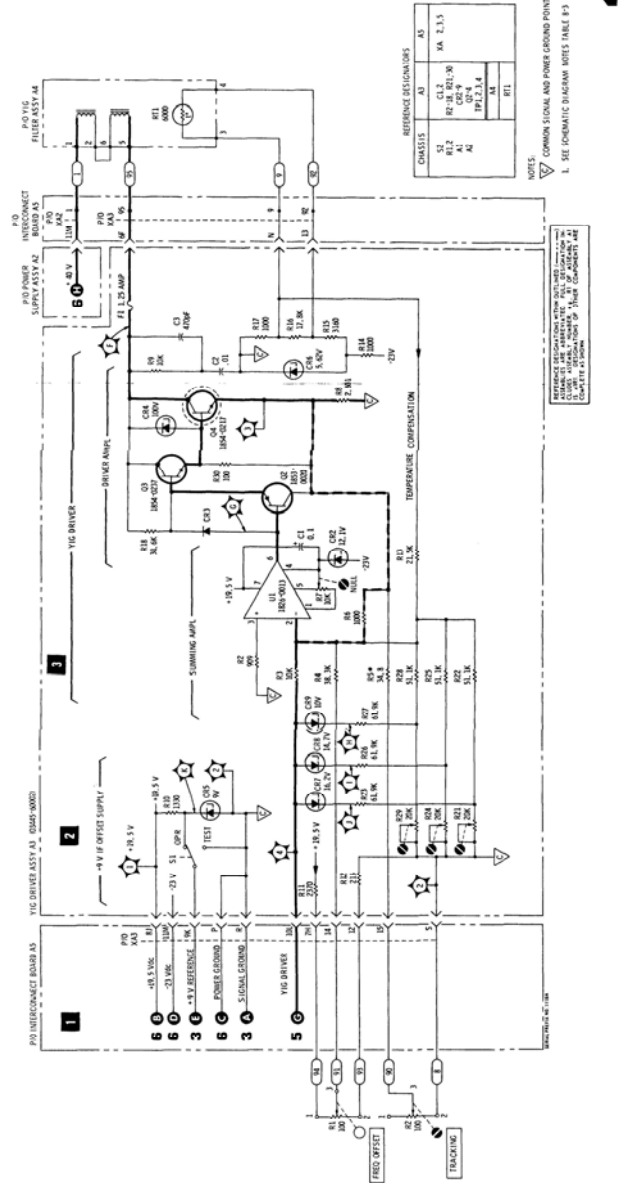

Figure 8-14. Yig Driver Assembly A3, Component Location



4

Figure 8-15. Yig Driver Circuits, Schematic Diagram 8-17

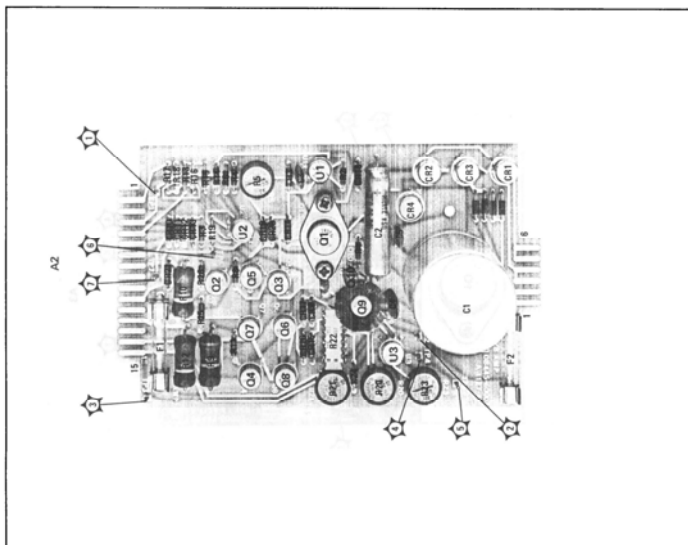

Figure 8-17. Power Supply Assembly A2, Component Location

SERVICE SHEET 5 (cont'd)

- 2 MANUAL CONTROL BUFFER AMPLIFIER**
Check operational amplifier A2U2 for unity gain and inversion of input voltage. (Compare input voltage at A2U2 Pin 2 with output at A2TP4.) See paragraph 8-30 for Operational Amplifier troubleshooting procedure.
- 3 REMOTE CONTROL BUFFER AMPLIFIER**
Connect a +10 volt power supply to REMOTE input (positive to center conductor and negative to shield). Check operational amplifier A2U3 for unity gain and inversion of input voltage at A2TP4. See paragraph 8-30 for Operational Amplifier troubleshooting procedure. See paragraph 5-10 for Remote Control Buffer Amplifier Adjustment.
- 4 AUTOMATIC SWITCHING CONTROL CIRCUITRY**
Check relay driver A3Q1 and relay A3K1. A3Q1 should be saturated and relay A3K1 energized except when Preslector is in Remote Operating Mode. The Preslector automatically switches to Remote Operating Mode when the Analyzer's power is removed or when interconnect cable W3 is disconnected.

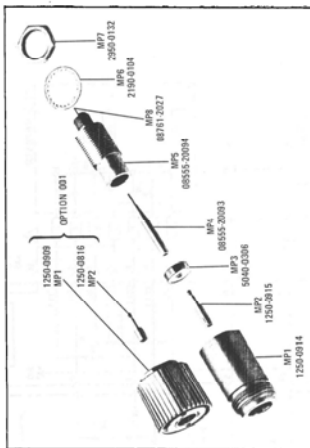

Figure 8-16. Filter Four Connector, Exploded View

SERVICE SHEET 5
Switching, Manual and Remote Control

SERVICE SHEET 5 (cont'd)

- through interconnect cable W3 to the base of transistor A3Q1. The +20 volt supply A3Q1 is routed through contacts 1 and 3 of A3K1 and then through the interconnect wiring to the Yig Driver circuitry. When the +20 volt supply is disconnected, the Yig Driver circuitry will be disconnected from cable (disconnected) A3K1 deenergizes and the output of the amplifier is routed through contacts 1 and 3 of A3K1 to the Yig Driver circuitry. Also, the inhibit line to the coaxial switch driver (1 above) is routed through contacts 2 and 6 of A3K1. This voltage is supplied via a jumper between pins 2 and 6 of A3K1. The output of the Preslector and remote control amplifiers is routed through MODE switch S2 to the Yig Driver. The signal path to the Yig Driver through A3K1 is broken by removal of a jumper between pins 5 and 19 of A3K1.
- TROUBLESHOOTING PROCEDURE**
When a malfunction has been isolated to the Coaxial Switch Driver, Manual Control Buffer Amplifier, Remote Control Buffer Amplifier or Automatic Switching Control circuit, perform the following test procedure. Connect Preslector to Analyzer, apply power and allow instruments to warm up and stabilize. Connect a voltmeter to the test points shown on the test points of amplifiers A2U2 and A2U3. Make all voltage measurements in reference to A3TP2 (common ground point).
- EQUIPMENT REQUIRED**
8555A Spectrum Analyzer HP 8555A (AS20/140)
DC Power Supply HP 3449A
Power Supply HP 6253B
- COAXIAL SWITCH DRIVER**
Set Analyzer controls as follows: BAND \rightarrow n+1— (550 MHz IF), FREQUENCY to 1.5 GHz, and SCAN WIDTH to ZERO. On Presectors with Frequency Tuning, set Preslector to Frequency Tuning. Select test point "A". Press Frequency BAND Lever on 8555A RF Section to select BANDS n+1— (450 MHz IF) through n+4—. Note voltage level indicated for each band. The voltage level should be approximately +19.5 volts on all bands. The +10 volt level should be approximately +15.5 volts on all bands. Compare test results with typical levels given below. Use approximately 0 volt. Check voltage levels at test points "B", "C", "D", and "E" for both n+1— (2.05 GHz IF) and n+1— (550 MHz IF) bands. Use transistor cases (A2Q2, Q3 and Q4) for test points "B", "C", "D", and "E". Compare level with typical levels given below.

Test Point	Voltage Level	
	BAND n+1— (2.05 GHz IF)	BAND n+1— (550 MHz IF)
AZTP "B"	+39.5V	0V
AZTP "C"	+2.7V	+39.7V
AZTP "D"	+3.3V	+39.7V
AZTP "E"	+3.5V	+39.7V

SERVICE SHEET 5

THEORY OF OPERATION

Service Sheet 5 contains the schematic diagrams for the coaxial switch driver, manual control amplifier, remote control amplifier, and the automatic switching control circuitry.

1 COAXIAL SWITCH DRIVER

The coaxial switch driver provides control voltage to coaxial relays to connect the Yig filter to the low-pass filter to the front panel ports. The direction of the Yig filter is controlled by the direction of the coaxial switch driver. The direction of the Yig filter is controlled by the direction of the coaxial switch driver. In the AUTO MODE of operation, A2Q2 and diode CR10, CR13 perform the function of the coaxial switch driver. The direction of the Yig filter is controlled by the direction of the coaxial switch driver. In the MANUAL or REMOTE mode, the coaxial relays are driven to the low-pass filter position. Transistors A2Q4 thru A2Q8 function as a double-pole double-throw switch driven by A2Q3. A2Q4 functions as an inverter driving switch A2Q6/Q8 to produce a voltage opposite that provided by A2Q5. A2Q5, A2Q6, A2Q7, A2Q8, and diodes CR14, CR15, CR16, and CR17 are connected to the Yig filter. The 40 volts difference between the two outputs is A2Q5/Q8 to provide approximately 20 volts drive to the switches to the Yig filter position. A more positive voltage at A2 pins 13/P drives the switches to the low-pass filter position.

2 MANUAL CONTROL BUFFER AMPLIFIER

The manual control buffer amplifier A2U2 generates an output voltage proportional to the manual control input. The output of the manual control (Manual Tune) controls are provided on instrument option 020 and 030. The COARSE tune control is calibrated in frequency from 0 to 20 GHz. The FINE tune control is calibrated from -300 to +500 MHz. A manual control input is provided to the manual control amplifier through a ratio of 1.025 GHz/V (Yig driver input sensitivity). The manual control amplifier provides a ratio of 1.025 GHz/V (Yig driver input sensitivity).

3 REMOTE CONTROL BUFFER AMPLIFIER

The remote input buffer amplifier generates a voltage at A2TP4 equal to the voltage difference on the floating BNC remote input. A2U3 and its common-mode rejection. Over-voltage protection is provided by A2CR15, CR16, and CR17. A2R24 reduces the input sensitivity to a ratio of 1.000 through MODE switch S2 and/or the automatic switching control (see 4 below).

4 AUTOMATIC SWITCHING CONTROL

Relay driver A3Q1 and Relay A3K1 provide automatic switching of the Yig driver input for instruments without manual controls. For those instruments, (S2 and option 010) +20 volts is supplied from the 8555A RF Section,

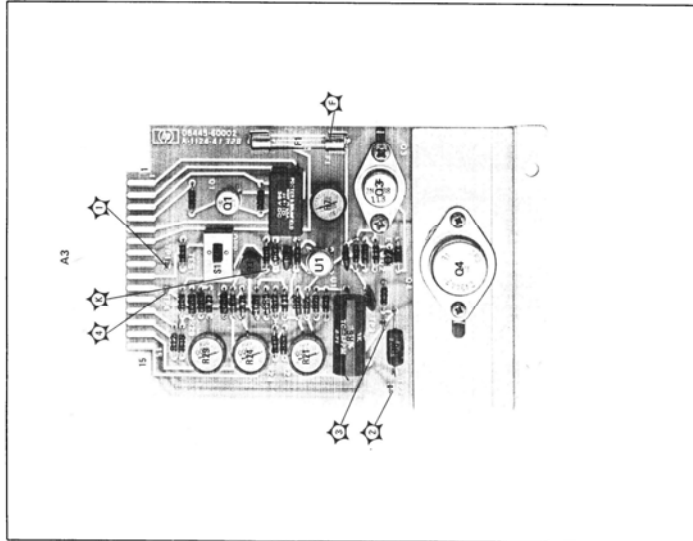

Figure 8-18. Yig Driver Assembly A3, Component Location

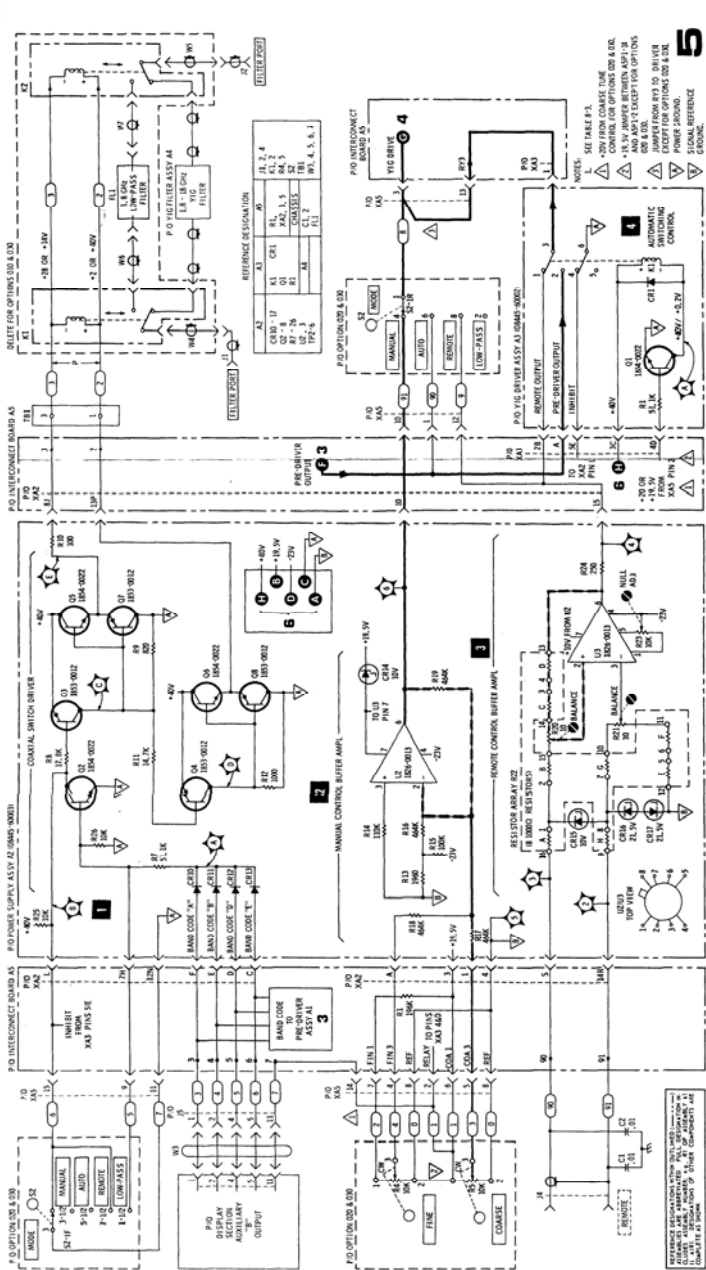

Figure 8-19. Remote and Manual Control Amplifier and Switching Circuits, Schematic Diagram

SERVICE SHEET 6 (cont'd)

7 +19.5 VOLT SUPPLY

Remove input line voltage from Preslector. Remove A2 assembly from Preslector. Check for a short on the +19.5 volt line external to the power supply. Typical resistance to power ground is 100 ohms. Check CR19 and CR20 assembly. Typical resistance to power ground is 1200 ohms. Check AZCR19 and CR20 assembly. Check fuse A2F1 and check transistor A2Q1 for open or short. Install A2 assembly, apply power and check for a 5.11 volt voltage drop across diode AZCR19. Typical voltage drop is 5.11 volts. Check CR19 and CR20 assembly at pin 3 with load at pin 2. Compare voltage level at A2U1 pin 3 with load at pin 2. Use junction of AZC3 and A2E2 with circuit traces to A2U1 for measurement points. Typical voltage levels given for a normal operating supply.

8 -23 VOLT SUPPLY

Remove input line voltage from Preslector. Remove A2 assembly from Preslector. Check for a short on the -23 volt line external to the power supply. Typical resistance to power ground A3TP2 from A5XA2 pin 9 is 400 ohms. A2 assembly should check diodes AZCR9 and CR21 for open or short. Check CR21 and CR20 assembly. Typical resistance to power ground is 200 ohms. Check diodes AZCR8 through CR8 and capacitor A2C2 for open or short. Install A2 assembly; apply power to Preslector. Check input to rectifiers AZCR8 thru CR8. Typical voltage level is 88 volts peak-to-peak.

SERVICE SHEET 6

THEORY OF OPERATION

POWER SUPPLY ASSEMBLY A2

Service Sheet 6 contains the schematic diagram for the +40, +19.5 and -23 volt power supplies. The service sheet also contains the schematic and wiring diagrams for the Preslector power supply and the Preslector power supply circuits. Power transformer T1 provides 27.7 V RMS at 1.5 Amp and 27.7 V RMS at 0.1 Amp input to the power supply.

+40 VDC AND +19.5 VDC POWER SUPPLIES

The 27.7 V RMS at 1.5 Amp input from power transformer T1 is rectified by diodes AZCR5-CR8 and filter by A2C2 to provide a +40 volt unregulated source. The +40 Vdc source is electronically regulated to provide a 19.5 Vdc source. A2U1 is a monolithic integrated circuit voltage regulator used to drive series pass transistor A2Q1. Current limiting is provided by resistor A2R1 and resistor A2R2. A2R1 is connected across the emitter base junction of the voltage regulator transistor. Overvoltage protection is provided by AZCR19, CR20 and A2F1. Voltage divider A2R4, R5 and R6 provides an adjustable reference voltage to the voltage regulator.

-23 VOLT POWER SUPPLY

The 27.7 V RMS at 0.1 Amp input from power transformer T1 is rectified by diodes AZCR5-CR8 and filter by A2C2 to provide a -40 volt unregulated source. The -40 volt source is electronically regulated to -23 volts. The -23 volt source is electronically regulated to -23 volts by diode AZCR21 and resistor A2R2. Overvoltage protection is provided by breakdown diode A2C2 with overvoltage protection provided by breakdown diode AZCR21.

TROUBLESHOOTING PROCEDURE

When a malfunction has been isolated to one of the three power supplies or to isolate a malfunction in one of the supplies, perform the following procedure. Make all voltage measurements in reference to A3TP2 (common ground point).

EQUIPMENT REQUIRED

- Volt-Ohm-Ammeter HP 180A180A1821A
- HP 419A
- Centimeter HP 180A180A1821A

+40 VOLT SUPPLY

To check the +40 volt supply, remove input line voltage from Preslector and remove fuse A2F1 to isolate the +19.5 volt supply from the +40 volt supply. Check diodes AZCR1 thru CR4 and capacitor A2C1 for open or short. Check CR4 and CR3 assembly. Typical resistance to power ground A3TP2 from A5XA2 pin 11 is 2400 ohms with A2 removed. Apply power to Preslector and check input to rectifiers AZCR1 thru CR4. Typical voltage level is 98 volts peak-to-peak. (Preslector not connected to analyzer). Replace fuse A2F1.

Power Supplies

SERVICE SHEET 6

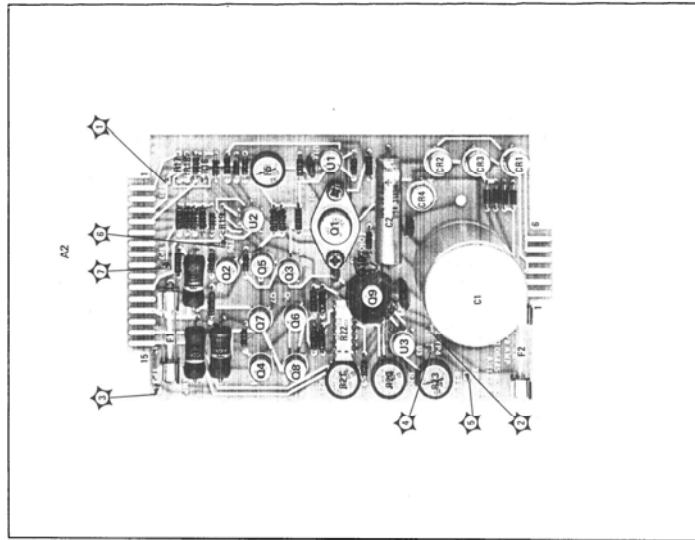
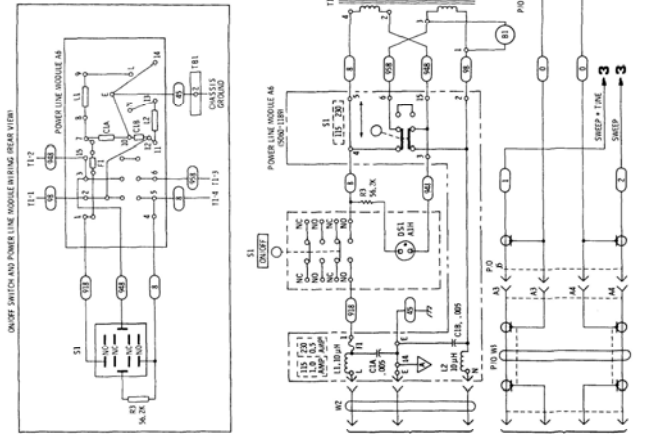

Figure 8-20. Power Supply Assembly A2, Component Location



ONOFF SWITCH AND POWER LINE MODULE IN REAR VIEW

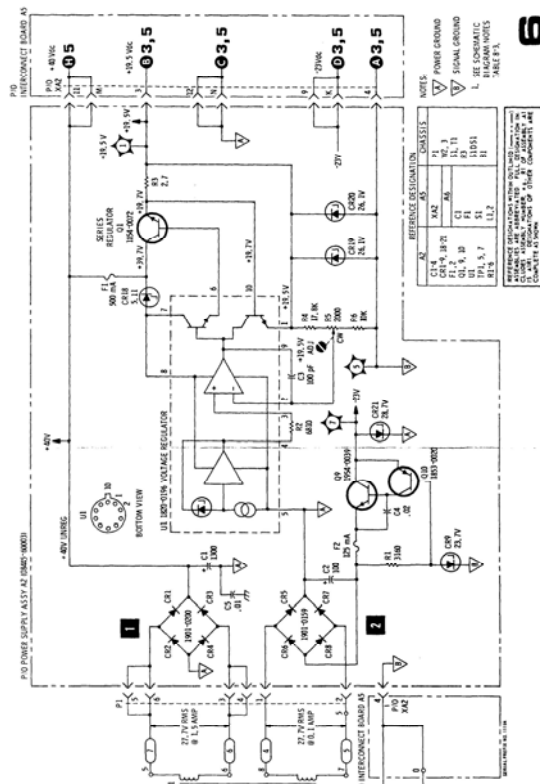
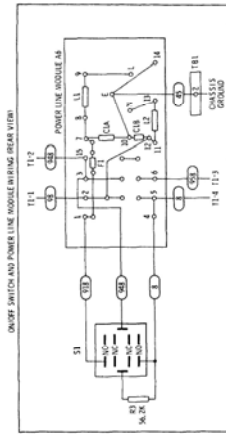

Figure 8-21. Power Supply Assembly A2, Schematic Diagram

MANUAL CHANGES

MANUAL IDENTIFICATION

Model Number: 8445A
Date Printed: Oct. 1971
Part Number: 08445-90002

This supplement contains important information for correcting manual errors and for adapting the manual to instruments containing improvements made after the printing of the manual.

To use this supplement:

Make all ERRATA corrections

Make all appropriate serial number related changes indicated in the tables below.

Serial Prefix or Number	Make Manual Changes	Serial Prefix or Number	Make Manual Changes
1144A	1		
▶ 1225A, 1237A	1, 2		
▶ 1237A	1, 2, 3		

▶ NEW ITEM

ERRATA

Page 1-3, Table 1-2:

Change second footnote to: **See paragraph 1-24 and Figure 1-4; item not supplied with Option 050.

Page 5-5, Paragraph 5-10,

Change to: Set power supply output voltage to zero and connect REMOTE connector center conductor to "—" terminal of power supply. (REMOTE center pin and shield now shorted together.)

Page 6-6, Table 6-2,

Change P1 to: 1251-0158 CONNECTOR: PC EDGE 6 PIN 76530 250-06-30-210

Page 8-13, Figure 8-7 and Page 8-17, Figure 8-15:

Change YIG Filter Assy A4 terminal 6 to read terminal 5 and change terminal 5 to read terminal 6.

CHANGE 1

Page 6-6, Table 6-2:

Add	MP4	5000-8595	COVER:SIDE PERFORATED (OLIVE GRAY)	28480	5000-8595
Change	MP4	to 5000-0731	COVER:SIDE PERFORATED (BLUE GRAY)	28480	5000-0731
Add	MP5	5020-6850	FRONT PANEL:TRIM BOTTOM (MINT GRAY)	28480	5020-6850
Change	MP5	to 5020-0900	FRONT PANEL: TRIM BOTTOM (LIGHT GRAY)	28480	5020-0900
Add	MP6	5020-6851	FRONT PANEL: TRIM TOP (MINT GRAY)	28480	5020-6851
Change	MP6	to 5020-0901	FRONT PANEL:TRIM TOP (LIGHT GRAY)	28480	5020-0901

(more)

NOTE

Manual change supplements are revised as often as necessary to keep manuals as current and accurate as possible. Hewlett-Packard recommends that you periodically request the latest edition of this supplement. Free copies are available from all HP offices. When requesting copies quote the manual identification information from your supplement, or the model number and print date from the title page of the manual.

7 September 1972

HEWLETT  PACKARD

Printed in U.S.A.

CHANGE 1 (cont'd)

Add	MP10	08443-40005	PANEL TRIM STRIP (MINT GRAY)	28480	08443-40005
Change	MP10	to 08443-40002	PANEL TRIM STRIP (LIGHT GRAY)	28480	08443-40002
Add	MP11	08445-00028	PLATE:CONNECTOR (OLIVE BLACK)	28480	08445-00028
Change	MP11	to 08445-00007	PLATE:CONNECTOR (BLACK)	28480	08445-00007
Add	MP13	08445-00024	PANEL:FRONT OPT 020/030 (MINT GRAY/OLIVE BLACK)	28480	08445-00024
Change	MP13	to 08445-00014	PANEL:FRONT OPT 020/030 (LIGHT GRAY/BLACK)	28480	08445-00014
Add	MP16	08445-00025	PANEL:FRONT STANDARD (MINT GRAY/OLIVE BLACK)	28480	08445-00025
Change	MP16	to 08445-00017	PANEL:FRONT STANDARD (LIGHT GRAY/BLACK)	28480	08445-00017
Add	MP17	08445-00026	COVER:TOP (OLIVE GRAY)	28480	08445-00026
Change	MP17	to 08445-00018	COVER:TOP (BLUE GRAY)	28480	08445-00018
Add	MP18	08445-00027	COVER:BOTTOM (OLIVE GRAY)	28480	08445-00027
Change	MP18	to 08445-00019	COVER:BOTTOM (BLUE GRAY)	28480	08445-00019
Add	MP23	5060-8543	BRACKET:JOINING KIT (OLIVE GRAY)	28480	5060-8543
Change	MP23	to 5060-0216	BRACKET:JOINING KIT (BLUE GRAY)	28480	5060-0216
Add	MP24	5060-8739	KIT:RACK MOUNTING (MINT GRAY)	28480	5060-8739
Change	MP24	to 5060-0774	KIT:RACK MOUNTING (LIGHT GRAY)	28480	5060-0774

► **CHANGE 2**

Pages 5-9 and 5-12, add at end of procedures 5-11 and 5-12:

NOTE
See Table 8-1.

Page 6-4, Table 6-2:

Change	A3R5;	delete, Factory Selected Part		
Change	A3R8	to 0811-3243	R:FXD WW 2.675 OHM 0.1% 2-1/2 W	28480 0811-3243
Add	A3R19	0757-0401	R:FXD MET FLM 100 OHM 1% 1/8 W Factory Selected Part	28480 0757-0401

Page 6-5, Table 6-2:

Change	A3R23	to 0757-0458	R:FXD MET FLM 51.1K OHM 1% 1/8 W Factory Selected Part	28480 0757-0458
Change	A3R26	to 0757-0460	R:FXD MET FLM 61.9K OHM 1% 1/8 W Factory Selected Part	28480 0757-0460

Page 8-1, insert new Table 8-1:

Table 8-1. Factory Selected Components

Designation	Circuit	Purpose
A3R19	YIG Driver	Center TRACKING control R2
A3R23	YIG Driver	Center 18 GHz adjust A3R21
A3R26	YIG Driver	Center 15 GHz adjust A3R24

Page 8-17, Figure 8-15:

- Change R5* to R5
- Change R8 value to 2.675
- Add R19* 100 in parallel with R8, 2.675
- Change R23 61.9K to R23* 51.1K
- Change R26 to R26*

► **CHANGE 3**

Page 6-4, Table 6-2:

Change A2R10 to 0764-0013 R:FXD MET OX 56 OHM 5% 2 W

28480 0764-0013

Page 8-19, Figure 8-19:

Change R10 100 to R10 56

HEWLETT · PACKARD

ELECTRONIC INSTRUMENTATION SALES AND SERVICE

UNITED STATES, CENTRAL AND SOUTH AMERICA, CANADA

UNITED STATES

ALABAMA
P.O. Box 4207
2003 Byrd Spring Road S.W.
Huntsville 35802
Tel: (205) 881-4591
TWX: 810-726-2204

ARIZONA
2336 E. Magnolia St.
Phoenix 85034
Tel: (602) 252-5061
TWX: 910-951-1330

5737 East Broadway
Tucson 85716
Tel: (602) 298-2113
TWX: 910-952-1152

CALIFORNIA
1430 East Orangethorpe Ave.
Fullerton 92631
Tel: (714) 870-1000

3539 Lankershim Boulevard
North Hollywood 91604
Tel: (213) 877-1282
TWX: 910-499-2170

1101 Embarcadero Road
Palo Alto 94303
Tel: (415) 327-5500
TWX: 910-373-1280

2220 Watt Ave.
Sacramento 95825
Tel: (916) 482-1463
TWX: 910-367-2092

9606 Aero Drive
San Diego 92123
Tel: (714) 279-3200
TWX: 910-335-2000

COLORADO
7965 East Prentice
Englewood 80110
Tel: (303) 771-3455
TWX: 910-935-0705

CONNECTICUT
508 Tolland Street
East Hartford 06108
Tel: (203) 853-1251
TWX: 710-425-3416

111 East Avenue
Norwalk 06851
Tel: (203) 853-1251
TWX: 710-468-3750

FLORIDA
P.O. Box 24210
2806 W. Oakland Park Blvd.
Ft. Lauderdale 33307
Tel: (305) 731-2020
TWX: 510-955-4099

P.O. Box 20007
Herndon Station 32814
621 Commonwealth Avenue
Orlando
Tel: (305) 841-3970
TWX: 810-850-0113

GEORGIA
P.O. Box 28234
450 Interstate North
Atlanta 30328
Tel: (404) 436-6181
TWX: 810-766-4890

ILLINOIS
5500 Howard Street
Skokie 60076
Tel: (312) 677-0400
TWX: 910-223-3613

INDIANA
1839 Meadows Drive
Indianapolis 46205
Tel: (317) 546-4891
TWX: 810-341-2653

LOUISIANA
P.O. Box 856
1942 Williams Boulevard
Kenner 70062
Tel: (504) 721-6201
TWX: 810-955-5524

MARYLAND
6707 Whittlesome Road
Baltimore 21207
Tel: (301) 944-5400
TWX: 710-862-9157

P.O. Box 1648
2 Choke Cherry Road
Rockville 20850
Tel: (301) 948-6370
TWX: 710-828-9684

MASSACHUSETTS
32 Hartwell Ave.
Lexington 02173
Tel: (617) 861-8960
TWX: 710-325-6904

MICHIGAN
21840 West Nine Mile Road
Southfield 48075
Tel: (313) 353-9100
TWX: 810-224-4882

MINNESOTA
2459 University Avenue
St. Paul 55114
Tel: (612) 645-9451
TWX: 910-563-3734

MISSOURI
11131 Colorado Ave.
Kansas City 64137
Tel: (816) 763-8000
TWX: 910-771-2087

2812 South Brentwood Blvd.
St. Louis 63144
Tel: (314) 962-5000
TWX: 910-760-1670

NEW JERSEY
W. 120 Century Road
Paramus 07652
Tel: (201) 265-5000
TWX: 710-990-4951

1060 N. Kings Highway
Cherry Hill 08034
Tel: (609) 667-4000
TWX: 710-892-4945

NEW MEXICO
P.O. Box 8356
Station C
6501 Lomas Boulevard N.E.
Albuquerque 87108
Tel: (505) 265-3713
TWX: 910-989-1665

156 Wyatt Drive
Las Cruces 88001
Tel: (505) 526-2485
TWX: 910-983-0550

NEW YORK
1702 Central Avenue
Albany 12205
Tel: (518) 869-8462
TWX: 710-441-8270

1219 Camville Road
Endicott 13750
Tel: (607) 754-0050
TWX: 510-252-0890

82 Washington Street
Poughkeepsie 12601
Tel: (914) 454-7330
TWX: 510-248-0012

39 Saginaw Drive
Rochester 14623
Tel: (716) 473-9500
TWX: 510-253-5981

5858 East Molloy Road
Syracuse 13211
Tel: (315) 454-2486
TWX: 710-541-0482

1 Crossways Park West
Woodbury 11797
Tel: (516) 921-0300
TWX: 510-223-0811

NORTH CAROLINA
P.O. Box 5188
1923 North Main Street
High Point 27262
Tel: (919) 885-8101
TWX: 510-926-1516

OHIO
25575 Center Ridge Road
Cleveland 44145
Tel: (216) 835-0300
TWX: 810-427-9129

3460 South Dixie Drive
Dayton 45439
Tel: (513) 298-0351
TWX: 810-459-1925

1120 Morse Road
Columbus 43229
Tel: (614) 846-1300

OKLAHOMA
2919 United Founders Boulevard
Oklahoma City 73112
Tel: (405) 848-2801
TWX: 910-830-6882

OREGON
Westhills Mall, Suite 158
4475 S.W. Scholls Ferry Road
Portland 97225
Tel: (503) 292-9171
TWX: 910-464-6103

PENNSYLVANIA
2500 Moss Side Boulevard
Monroeville 15146
Tel: (412) 271-0724
TWX: 710-797-3650

1021 8th Avenue
King of Prussia Industrial Park
King of Prussia 19406
Tel: (215) 265-7000
TWX: 510-660-2670

RHODE ISLAND
873 Waterman Ave.
East Providence 02914
Tel: (401) 434-5535
TWX: 710-381-7573

TEXAS
P.O. Box 1270
201 E. Arapaho Rd.
Richardson 75080
Tel: (214) 231-6103
TWX: 910-867-4723

P.O. Box 22813
6300 Westpark Drive
Suite 100
Houston 77027
Tel: (713) 781-6000
TWX: 910-881-2645

231 Billy Mitchell Road
San Antonio 78225
Tel: (512) 434-4171
TWX: 910-871-1170

UTAH
2890 South Main Street
Salt Lake City 84115
Tel: (801) 487-0715
TWX: 910-925-5681

VERMONT
P.O. Box 2287
Kennedy Drive
South Burlington 05401
Tel: (802) 658-4455
TWX: 910-299-0025

VIRGINIA
P.O. Box 6514
2111 Spencer Road
Richmond 23230
Tel: (703) 285-3431
TWX: 710-956-0157

WASHINGTON
43110th N.E.
Bellevue 98004
Tel: (206) 454-3971
TWX: 910-443-2303

***WEST VIRGINIA**
Charleston
Tel: (304) 768-1232

FOR U.S. AREAS NOT LISTED:
Contact the regional office nearest you: Atlanta, Georgia... North Hollywood, California... Paramus, New Jersey... Skokie, Illinois. Their complete addresses are listed above.

*Service Only

CENTRAL AND SOUTH AMERICA

ARGENTINA
Hewlett-Packard Argentina
S.A.C.e.I.
Lavalle 1171 - 3°
Buenos Aires
Tel: 35-0405; 35-0627; 35-0431
Telex: 012-1009
Cable: HEWPACKARG

BRAZIL
Hewlett-Packard Do Brasil
i.e.C. Ltda.
Rua Frei Caneca 1119
Sao Paulo - 3, SP
Tel: 288-7111; 287-5858
Cable: HEWPACK Sao Paulo

Hewlett-Packard Do Brasil
Praca Dom Feliciano 78
Salas 806-808
Porto Alegre
Rio Grande do Sul - RS - Brasil
Tel: 25-8470
Cable: HEWPACK Porto Alegre

Hewlett-Packard Do Brasil
i.e.C. Ltda.
Rua da Matrix 29
Botafogo - 20-02
Rio de Janeiro, GB
Tel: 246-4417
Cable: HEWPACK Rio de Janeiro

Hewlett-Packard Do Brasil
Industria e Comercio Ltda.
Praca Dom Feliciano 78
Salas 806-8
Porto Alegre RGS
Tel: 25-0405; 35-0627; 35-0431
Telex: 012-1009
Cable: HEWPACKARG

CHILE
Héctor Calcagni y Cia, Ltda.
Bustos, 1932-3er Piso
Casilla 13942
Santiago
Tel: 423-96
Cable: CALCAGNI Santiago

COLOMBIA
Instrumentación
Henrik A. Langebaek & Kier
Ltda.
Carrera 7 No. 48-59
Apartado Aereo 6287
Bogotá, I. D. E.
Tel: 45-78-06; 45-55-46
Cable: AARIS Bogotá
Telex: 44-000 INWSTCO

COSTA RICA
Lic. Alfredo Gallegos Gurdian
Apartado 10159
San José
Tel: 21-86-13
Cable: GALGUR San José

ECUADOR
Laboratorios de Radio-Ingeniería
Calle Guayaquil 1246
Post Office Box 3199
Quito
Tel: 212-496; 219-185
Cable: HORVATH Quito

EL SALVADOR
Electrónica
Apartado Postal 1589
Bld. Venezuela 1231
San Salvador
Tel: 21757; 214895
Cable: ELECTRONICA
San Salvador

MEXICO
Hewlett-Packard Mexicana, S.A.
de C.V.
622 Adolfo Prieto
Col. del Valle
Mexico 12, D.F.
Tel: 543-4232; 523-1874
Telex: 0017-74507

NICARAGUA
Roberto Terán G.
Apartado Postal 689
Edificio Terán
Managua
Tel: 3451; 3452
Cable: ROTERAN Managua

PANAMA
Electrónica Baiboa, S.A.
P.O. Box 4929
Ave. Manuel Espinosa No. 13-50
Bldg. Alina
Panama City
Tel: 230833
Telex: 3881003, Curundu.
Canal Zone
Cable: ELECTRON Panama City

PERU
Compañía Electro Medica S.A.
Ave. Enrique Canaval 312
San Isidro
Casilla 1030
Lima
Tel: 22-3900
Cable: ELMED Lima

PUERTO RICO
San Juan Electronics, Inc.
P.O. Box 5167
Ponce de Leon 154
Pda. 3-PTA de Tierra
San Juan 00906
Tel: (809) 729-3342; 722-3342
Cable: SATRONICS San Juan
Telex: SATRON 3450 332

SURINAME
Surtel-Radio Holland N.V.
P.O. Box 155
Paramaribo
Tel: 72118
Cable: Treurniet Paramaribo

URUGUAY
Pablo Ferrando S.A.
Comercial e Industrial
Avenida Italia 2877
Casilla de Correo 370
Montevideo
Tel: 40-3102
Cable: RADIUM Montevideo

VENEZUELA
Hewlett-Packard De Venezuela
C.A.
Apartado 50933
Caracas
Tel: 71-88-05; 71-88-69; 71-99-30
Cable: HEWPACK Caracas
Telex: 39521146

FOR AREAS NOT LISTED,
CONTACT:
Hewlett-Packard
INTERCONTINENTAL
3200 Hillview Ave.
Palo Alto, California 94304
Tel: (415) 493-1501
TWX: 910-373-1267
Cable: HEWPACK Palo Alto
Telex: 034-8461

CANADA

ALBERTA
Hewlett-Packard (Canada) Ltd.
11745 Jasper Ave.
Edmonton
Tel: (403) 482-5561
TWX: 610-831-2431

BRITISH COLUMBIA
Hewlett-Packard (Canada) Ltd.
4519 Canada Way
North Burnaby 2
Tel: (604) 433-8213
TWX: 610-922-5059

MANITOBA
Hewlett-Packard (Canada) Ltd.
511 Bradford Ct.
Winnipeg
Tel: (204) 786-7581
TWX: 610-671-3531

NOVA SCOTIA
Hewlett-Packard (Canada) Ltd.
2745 Dutch Village Rd.
Suite 206
Halifax
Tel: (902) 455-0511
TWX: 610-271-4482

ONTARIO
Hewlett-Packard (Canada) Ltd.
880 Lady Ellen Place
Ottawa 3
Tel: (613) 722-4223
TWX: 610-562-1952

Hewlett-Packard (Canada) Ltd.
50 Galaxy Blvd.
Rexdale
Tel: (416) 677-9611
TWX: 610-492-4246

QUEBEC
Hewlett-Packard (Canada) Ltd.
275 Hymus Boulevard
Pointe Claire
Tel: (514) 697-4232
TWX: 610-422-3022
Telex: 01-20607

FOR CANADIAN AREAS NOT LISTED:
Contact Hewlett-Packard (Canada) Ltd. in Pointe Claire, at the complete address listed above.

